

Panasonic®

Multimedia Projection HDTV Operating Instructions

Models No. **PT-56DLX76/PT-61DLX76/
PT-61DLX26**

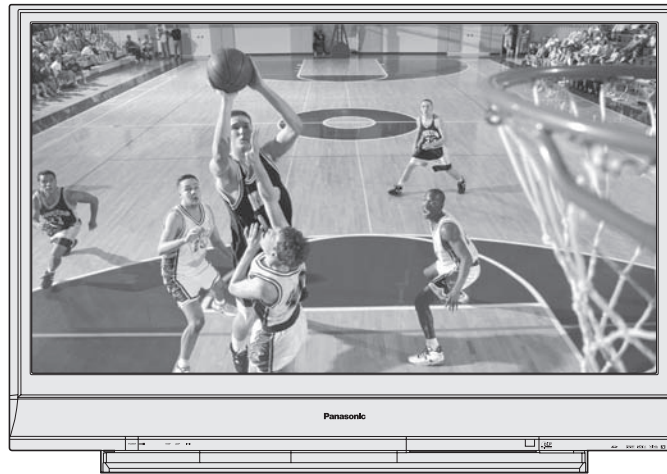

HDTV
—INTEGRATED TUNER—

DOLBY
DIGITAL

SD
TM

VIVA
HD3D Sound **DVE.**

HDMI™
HIGH-DEFINITION MULTIMEDIA INTERFACE

TV
GUIDE

PICTURE BY
DLP
TEXAS INSTRUMENTS

(USA)

For assistance, please call :
1-888-VIEW PTV(843-9788)
or, contact us via the web at:
<http://www.panasonic.com/contactinfo>

(Puerto Rico)

For assistance, please call :
787-750-4300
or visit us at www.panasonicpr.com

Three Important Reasons to Register Your Product Immediately!

- 1 Protect Your New Investment...**
Register your new Projection Display for insurance purposes in case your new Projection Display is stolen.
- 2 Product safety notification...**
Registering your product can help us to contact you in the unlikely event a safety notification is required under the Consumer Product Safety Act.
- 3 Improved Product Development...**
Help us continue to design products that meet your needs. Register online at www.panasonic.com/register



* The presence of the DTV certification mark indicates that this product will successfully receive digital television transmissions that conform to any and all of the video formats described in the ATSC Digital Television Standard.



As an **ENERGY STAR®** Partner, Panasonic Corporation of North America has determined that this product or product model meets the **ENERGY STAR®** guidelines for energy efficiency.

This operating instruction book is designed for use with models PT-56DLX76, PT-61DLX76 and PT-61DLX26. Illustrations in this manual show the PT-56DLX76.

Before connecting, operating or adjusting this product, please read the instructions completely. Please keep this manual for future reference.

⚠ IMPORTANT SAFETY INSTRUCTIONS



This symbol warns the user that uninsulated voltage within the unit may have sufficient magnitude to cause electric shock. Therefore, it is dangerous to make any kind of contact with any inside part of this unit.



This symbol alerts the user that important literature concerning the operation and maintenance of this unit has been included. Therefore, it should be read carefully in order to avoid any problems.



The pictorial representation of a hot surface within a triangle is intended to tell the user that parts inside the product are a risk of burns to persons.

Note to CATV System Installer:

This reminder is provided to call the CATV system installer's attention to Article 820-40 of the NEC that provides guidelines for proper grounding and, in particular, specifies that the cable ground shall be connected to the grounding system of the building, as close to the point of cable entry as practical.

⚠ WARNING

To reduce the risk of electric shock, fire, injury to persons or damage to this product:

- 1) **Read these instructions** before using, connecting or adjusting this product.
- 2) **Keep these instructions** for future reference.
- 3) **Heed all warnings** on the product and in this Operating Instructions manual.
- 4) **Follow all instructions** carefully.
- 5) **Do not use this apparatus near water.** For example, near a bathtub, washbowl, kitchen sink, or laundry tub, in a wet basement or near a swimming pool, and the like. Do not place objects filled with water, such as a vase or the like, on top of this unit.
- 6) **Clean only with a dry cloth.** Do not use liquid cleaners or aerosol cleaners.
- 7) **Do not block any ventilation openings. Install in accordance with the manufacturer's instructions.** Openings in the cabinet are provided for ventilation to ensure reliable operation and to protect it from overheating. Never block openings by placing the product on a bed, sofa or similar surfaces.
- 8) **Do not install near any heat source such as radiators, heat registers, stoves, or other apparatus (including amplifiers) that produces heat.** Do not install in a built-in installation such as a bookcase or rack, unless proper ventilation is provided or the manufacturer's instructions have been adhered to.
- 9) **Do not defeat the safety purpose of the polarized or grounding-type plug. A polarized plug has two blades with one wider than the other. A grounding type plug has two blades and a third grounding prong. The wide blade or the third prong are provided for your safety. If the provided plug does not fit into your outlet, consult an electrician for replacement of the obsolete outlet.**
- 10) **Protect the power cord from being walked on or pinched particularly at plugs, convenience receptacles, and the point where they exit from the apparatus.**
- 11) **Only use attachments/accessories specified by the manufacturer.**
- 12) **Use only with the cart, stand, tripod, bracket, or table specified by the manufacturer, or sold with the apparatus. When a cart is used, use caution when moving the cart/apparatus combination to avoid injury from tip-over.**
- 13) **Unplug this apparatus during lightning storms or when unused for long periods of time.**
- 14) **Refer all servicing to qualified service personnel. Servicing is required when the apparatus has been damaged in any way, such as power-supply cord or plug is damaged, liquid has been spilled or objects have fallen into the apparatus, the apparatus has been exposed to rain or moisture, does not operate normally, or has been dropped.**
- 15) Because the temperature of the lamp unit is elevated immediately after its use, a direct touch to it may cause burns. **Replace the lamp unit only after it has cooled.**



! IMPORTANT SAFETY INSTRUCTIONS (CONTINUED)

! WARNING

AS WITH ANY SMALL OBJECT, SD CARDS CAN BE SWALLOWED BY YOUNG CHILDREN. DO NOT ALLOW CHILDREN TO HANDLE THE SD CARD.

! WARNING

TO REDUCE THE RISK OF FIRE OR ELECTRIC SHOCK, DO NOT EXPOSE THIS EQUIPMENT TO RAIN OR MOISTURE. DO NOT PLACE OBJECTS FILLED WITH WATER, SUCH AS A VASE OR THE LIKE, ON TOP OF THIS APPARATUS.

! CAUTION

- (1) This Projection Display is intended to be used with the following TV stand: TY-56LC66 for the PT-56DLX76, TY-56LC16 for the PT-56DLX76, TY-61LC66 for the PT-61DLX76 or PT-61DLX26, and TY-61LC16 for the PT-61DLX76 or PT-61DLX26.
Use with other stands may result in the Projection Display becoming unstable, possibly causing injury.
- (2) This Projection Display should not be exposed to direct sunlight, extreme temperatures or moisture, as this can result in serious irreparable damage.
- (3) This Projection Display has a High Intensity Discharge (HID) lamp that contains a small amount of mercury. It also contains lead in some components.
Disposal of these materials may be regulated in your community due to environmental considerations.
For disposal or recycling information please contact your local authorities, or the Electronics Industries Alliance:
<<http://www.eiae.org>.>

The Lamp is a consumable item and has a limited life.

The lamp should be changed as soon as possible once the lamp warning message appears. (p. 76)

If the lamp is damaged, please contact your nearest dealer.

Due to the characteristics and use conditions of individual lamps, the lamp may cease to light before the stated lamp life. Influences of frequent lighting, continuous light use for over 24 hours, the number of times lit, the length of time between lightings, etc. may shorten lamp life.
(Because of this, we recommend having a replacement lamp on hand.)

U.S. Patent Nos. 4,631,603; 4,819,098; 4,907,093; 5,315,448; 6,381,747 and 6,516,132.

This product incorporates copyright protection technology that is protected by U.S. patents and other intellectual property rights. Use of this copyright protection technology must be authorized by Macrovision, and is intended for home and other limited viewing uses only unless otherwise authorized by Macrovision. Reverse engineering or disassembly is prohibited.

License description: To view the license information for software used in this product, press MENU button and select "Setup" "About" "License". (p. 67)

Note:

- Do not allow a still picture to be displayed for an extended period, as this can cause a permanent afterimage to remain on this unit. Examples of still pictures include logos, video games, computer images, teletext and images displayed in 4:3 mode.

Dear Panasonic Customer

Welcome to the Panasonic family of customers. We hope that you will have many years of enjoyment from your new Projection Display.

To obtain maximum benefit from your set, please read these Instructions before making any adjustments, and retain them for future reference.

Retain your purchase receipt also, and record the serial number of your set in the space provided on the rear cover of these instructions.

Visit our Panasonic Web Site for USA : www.panasonic.com

(USA)

For assistance, please call : 1-888-VIEW PTV(843-9788)
or, contact us via the web at: <http://www.panasonic.com/contactinfo>

(Puerto Rico)

For assistance, please call : 787-750-4300
or visit us at www.panasonicpr.com

FCC STATEMENT:

NOTE:

This equipment has been tested and found to comply with the limits for a Class B digital device, pursuant to Part 15 of the FCC Rules. These limits are designed to provide reasonable protection against harmful interference in a residential installation. This equipment generates, uses and can radiate radio frequency energy and, if not installed and used in accordance with the instructions, may cause harmful interference to radio communications. However, there is no guarantee that interference will not occur in a particular installation. If this equipment does cause harmful interference to radio or television reception, which can be determined by turning the equipment off and on, the user is encouraged to try to correct the interference by one or more of the following measures:

- Reorient or relocate the receiving antenna.
- Increase the separation between the equipment and receiver.
- Connect the equipment into an outlet on a circuit different from that to which the receiver is connected.
- Consult the dealer or an experienced radio / TV technician for help.

FCC Caution:

To assure continued compliance, follow the attached installation instructions and use only shielded interface cables when connecting to computer or peripheral devices. Any changes or modifications not expressly approved by the party responsible for compliance could void the user's authority to operate this equipment.

ANY CHANGES OR MODIFICATIONS TO THIS PTV RECEIVER NOT EXPRESSLY APPROVED BY PANASONIC CORPORATION OF NORTH AMERICA COULD CAUSE HARMFUL INTERFERENCE, WHICH WOULD VOID THE USER'S AUTHORITY TO OPERATE THIS EQUIPMENT.



The Class II insulation symbol (square within a square) indicates that this product has been evaluated and tested to comply with Class II insulation requirements.

Declaration of Conformity

Models Number: **PT-56DLX76/PT-61DLX76/PT-61DLX26**
Trade Name: Panasonic
Responsible party: Panasonic Corporation of North America
Address: One Panasonic Way Secaucus New Jersey 07094
Telephone number: 1-888-VIEW PTV(843-9788)

This device complies with Part 15 of the FCC Rules. Operation is subject to the following two conditions: (1) This device may not cause harmful interference, and (2) this device must accept any interference received, including interference that may cause undesired operation.

Table of Contents

To Start !	▲ IMPORTANT SAFETY INSTRUCTIONS	2
	Before Using	6
	Location of Controls	9
	Installation.....	12
Use Now !	Power ON / OFF	26
	Basic Menu Navigation	30
	Tuning channels	32
	Projection Display operation.....	37
	ASPECT Controls	41
	Split screen	42
Enjoy More !	Picture Adjustments.....	44
	Audio Adjustments.....	47
	Sleep Timer Feature	49
	Lock Feature	50
	Photo Viewer.....	54
	TV Guide.....	58
	Setup Features	64
Other Information !	Operating Peripheral Equipment	70
	Remote Control Operation/Code List	71
	Warning Indicators	75
	Replacing the lamp unit.....	76
	Troubleshooting	78
	Specifications	80
	Cleaning	81
	Customer Services Directory	82
	Limited Warranty	83
	Other Information	84
Index	91	

Before Using

Receiver Location

This Projection Display is intended to be used with an optional stand or entertainment center. Consult your dealer for available options.

Locate for comfortable viewing. Avoid placing where sunlight or other bright light (including reflections) will fall on the screen.

Use of some types of fluorescent lighting can reduce Remote Control transmitter range.

Adequate ventilation is essential to prevent internal component failure. Keep away from areas of excessive heat or moisture.

Optional External Equipment

The Video / Audio connection between components can be made with shielded video and audio cables. For best performance, video cables should utilize 75 Ω coaxial shielded cables. Cables are available from your dealer or electronic supply house.

Before you purchase any cables, be sure you know what type of output and input connectors your various components require. Also determine the length of cable you'll need.

Safety Precaution

Please take safety precautions to prevent the unit from falling over.

WARNING

The unit may tip or fall if not situated on a stable surface, if pushed or during an earthquake. Use a strong rope or chain (not included) to fasten the Projection Display firmly to a strong wall support.

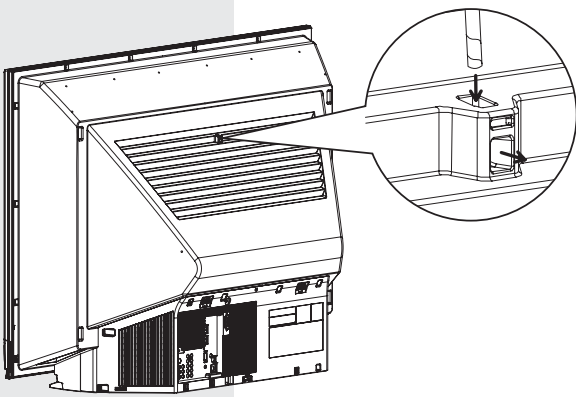

Accessories

1. Remote Control (EUR7737Z10)
2. Batteries 2 "AA"
3. IR Blaster (LSGQ0212)

Viewing position

To optimize your viewing comfort, please follow the viewing guidelines shown in the diagrams below. If viewing for an extended period of time, sit as far back from the screen as possible.

<Top view>

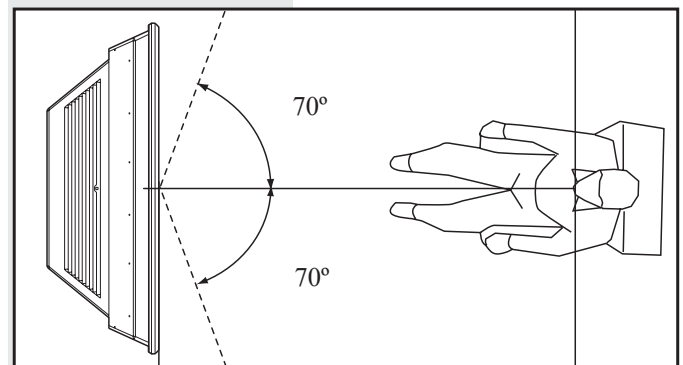

At least
2.1 m (PT-56DLX76) / 2.2 m (PT-61DLX76/
PT-61DLX26).

<Side view>

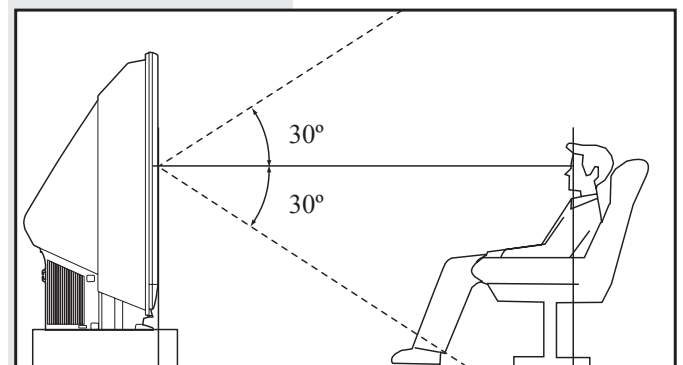

At least
2.1 m (PT-56DLX76) / 2.2 m (PT-61DLX76/
PT-61DLX26).

Remote Control Battery Installation

Requires two AA batteries (supplied).

1. While pressing in on the catch, open cover in direction of arrow.

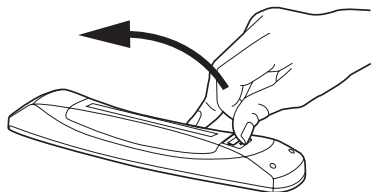

2. Install batteries in the battery compartment.

- Battery polarity (+) and (-) must match the markings inside the compartment.

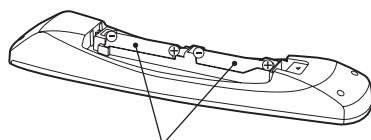

Two AA size

3. Press cover until it snaps shut.

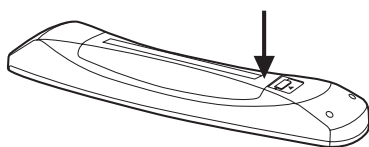

CAUTION

Incorrect battery installation can cause the batteries to leak, leading to personal injury and/or damage to the Remote Control.

Observe the following precautions:

1. Always replace batteries with a pair of new ones.
2. Do not combine a new battery with an old one.
3. Do not mix battery types (example: "Zinc Carbon" with "Alkaline").
4. Do not attempt to charge, short-circuit, disassemble, heat or burn used batteries.
5. Battery replacement is necessary when the Remote Control acts sporadically or stops operating the Projection Display set.

Helpful Hints:

- (1) Frequent Remote Control users, choose long-lasting Alkaline batteries as replacements.
- (2) Whenever batteries are removed, **you may need to reset Remote Control infrared codes.** We suggest making a note of the codes on page 70 prior to setting up the remote.

Emergency Alert System (EAS) Forced Tuning

If a CableCARD™ is installed, the cable MSO (multiple system owner/operator) may provide an Emergency Alert System message. These messages are intended to alert the general public of important local or national emergency situations. In the event of receipt of one of these messages, the Projection Display shall immediately tune to the channel as directed by the EAS message. If the channel has been blocked using the parental control, the parental blocking has priority over the forced tune.

Reset All Memory Functions

Use when moving unit to a new location, or when First Time Setup needs to be done over.

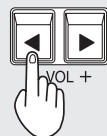

Press the VOL- button on the unit and OK button on the Remote Control at the same time for more than 3 seconds. Unit shuts itself off when reset is done.

- POWER indicator flashes red. After flashing stops, unplug the unit then plug it back in and turn power ON.



Note:

- When using "Control with HDMI (HDAVI Control)", with the device connected, set "Ctrl with HDMI" first to "Off" and then "On" using the Setup Menu. (p. 68)

Before Using (continued)

Glossary and Acronyms

CC (Closed Caption)

EAS (Emergency Alert System)

OSD (On-Screen Display)

MSO (Multiple system owner/operator)

Dolby Digital

This is a method of coding digital signals developed by Dolby Laboratories. Apart from stereo (2-channel) audio, these signals can also be multichannel audio. A large amount of audio information can be recorded on one disc using this method.

PCM (pulse code modulation)

These are uncompressed digital signals, similar to those found on CDs.

DTV (Digital Television)

Name of the process whereby television picture and sound signals are changed to digital code for receiving and transmitting.

HDTV (High Definition Television)

Television with improved picture quality by increasing vertical and horizontal resolution.

ATSC (Advanced Television Systems Committee)

Standardization body that developed the Digital Television Terrestrial formats.

HDMI (High Definition Multimedia Interface)

Interface that supports every uncompressed digital format as well as all existing multi-channel audio format on a single cable.

JPEG (Joint Photographic Experts Group)

A system used for compressing/decoding color still pictures.

MPAA (Motion Picture Association of America)

Guild governing rating assignments to movies.

NTSC (National Television Systems Committee)

Standardization body that developed the Analog Television Terrestrial formats.

Password

A four (4) digit code a user must provide in order to perform a function.

CableCARD™

A module that is required to receive premium digital services through the cable input.

Trademarks

Trademarks

- VGA and XGA are trademarks of International Business Machines Corporation.
- Macintosh is a registered trademark of Apple Computer, USA.
- SVGA is trademark of the Video Electronics Standard Association.
- Even if no special notation has been made of company or product trademarks, these trademarks have been fully respected.
- Equipped with **dbx**®-TV Noise Reduction for true MTS reproduction. **dbx**®-TV Noise Reduction is required for good stereo separation and audio fidelity. **dbx**® is a registered trademark, and is licensed by **dbx**® Technology Licensing.
- CableCARD™ is a trademark of Cable Television Laboratories, Inc.



HDMI, the HDMI logo and High Definition Multimedia Interface are trademarks or registered trademarks of HDMI Licensing LLC.



SD Logo is a trademark.



Digital Light Processing™, DLP™, the DLP™ logo, and the DLP™ medallion are trademarks of Texas Instruments.



In the United States, TV Guide and other related marks are registered marks of Gemstar-TV Guide International, Inc. and/or one of its affiliates. In Canada, TV Guide is a registered mark of Transcontinental Inc., and is used under license by Gemstar-TV Guide International, Inc.

The TV Guide On Screen™ system is manufactured under license from Gemstar-TV Guide International, Inc. and/or one of its affiliates.

The TV Guide On Screen™ system is protected by one or more of the following United States patents 4,908,713; 6,498,895; 6,850,693; 6,396,546; 5,940,073; 6,239,794 to Gemstar-TV Guide International, Inc. and/or its subsidiaries.

Gemstar-TV Guide International Inc. and/or its related affiliates are not in any way liable for the accuracy or availability of the program schedule information or other data in the TV Guide On Screen system and cannot guarantee service availability in your area. In no event shall Gemstar-TV Guide International, Inc. and/or its related affiliates be liable for any damages in connection with the accuracy or availability of the program schedule information or other data in the TV Guide On Screen system.

Natural disasters, system trouble or other such factors may make it impossible for TV GUIDE to be used. Panasonic shall in no way be liable for any damages or losses related to the use of TV GUIDE.



Manufactured under license from BBE Sound, Inc. Licensed by BBE Sound, Inc. under one or more of the following US patents: 5510752, 5736897. BBE and BBE symbol are registered trademarks of BBE Sound, Inc.



Manufactured under license from Dolby Laboratories. Dolby and the double-D symbol are trademarks of Dolby Laboratories.

Location of Controls

Illuminated Remote Control

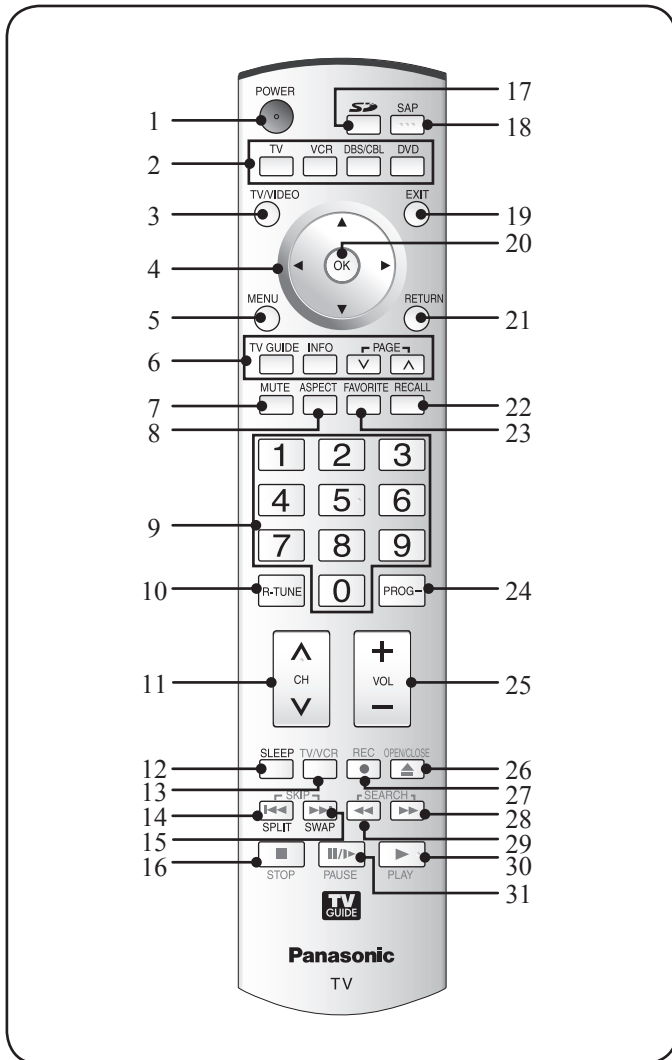

1	POWER	Press to turn ON and OFF.
2	TV	Sets the remote to control television or digital television.
	VCR, DBS/CBL, DVD	Sets the remote to control other devices.
3	TV/VIDEO	Changes Input source.
4	SELECT ▲▼◀▶	Controls navigation around on-screen menu.
5	MENU	Press to display Main Menu.
6	TV GUIDE	Press to enter the TV Guide.
	INFO	Press to display an information screen on TV Guide.
	PAGE ▼▲	Press to page scroll on TV Guide.
7	MUTE	Press to mute sound.
8	ASPECT	Changes display aspect ratio.
9	NUMBER	Press numeric keypad to select any channel or to make alpha-numeric entries in menus.

10	R-TUNE	Press to switch to previously viewed channel or input modes.
11	CH ▲▼	Press to change channels.
12	SLEEP	Sets unit to shut itself off after a preselected amount of time.
13	TV/VCR	Press to switch to TV or VCR.
14	SKIP ◀◀	While remote is in DVD mode, press to skip reverse.
	SPLIT	Press to display or delete Split screen.
15	SKIP ▶▶	While remote is in DVD mode, press to skip forward.
	SWAP	Press to swap Main screen with Split screen.
16	STOP	While remote is in VCR or DVD mode, press to stop.
17	SD	Accesses the Photo Viewer feature.
18	SAP	In analog mode, press to access audio modes (Stereo, SAP or Mono). In digital mode, press to access next audio track.
19	EXIT	Press to exit menus.
20	OK	Press to select menu and sub-menu items.
21	RETURN	Press to return one step backward in menus.
22	RECALL	Press to display or delete Channel banner.
23	FAVORITE	Press to operate the Favorite channel list function.
24	PROG	Press after entering a digital channel to enter a sub-channel.
25	VOL -+	Press to adjust TV sound.
26	OPEN/CLOSE	While remote is in DVD mode, press to open or close DVD tray.
27	REC	While remote is in VCR or DVD mode, press to record.
28	SEARCH ▶▶	While remote is in VCR or DVD mode, press to fast forward.
29	SEARCH ◀◀	While remote is in VCR or DVD mode, press to rewind.
30	PLAY	While remote is in VCR or DVD mode, press to play.
31	PAUSE	While remote is in VCR or DVD mode, press to pause.

Location of Controls (continued)

Controls and Terminals on the Projection Display

Front View <Model PT-56DLX76 unit shown>

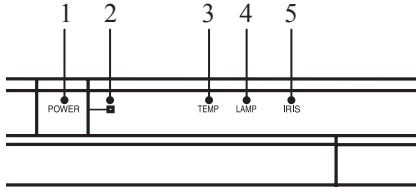

1	POWER button	Press to turn ON and OFF. (p. 75, 78)
2	POWER indicator	Lights up green when power is ON. (p. 26, 75)
3	TEMP indicator	Flashes when unit internal temperature is abnormal. (p. 75)
4	LAMP indicator	Lights up or flashes when the lamp unit is malfunctioning. (p. 75)
5	IRIS indicator	Lights up when "Dynamic iris" is set to "On". (p. 46)

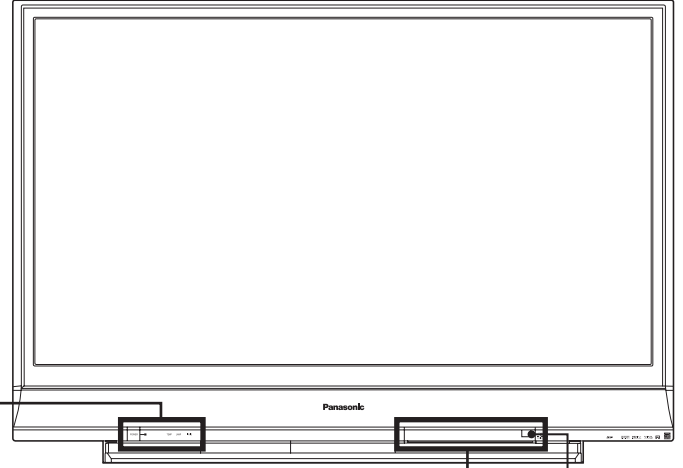

Remote Control Sensor

Open Door:
Press position ①, and slide Door open as shown by arrow.

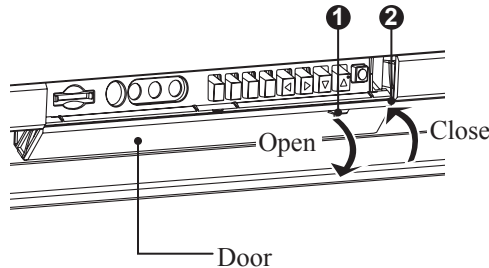

Close Door:
Press position ②, and slide Door closed as shown by arrow.

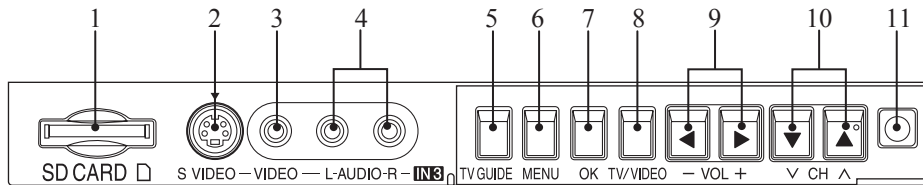

1	SD CARD Slot	Insert SD Card.
2	S-Video Input Connector 3	Connect from other component. (Video 3)
3	Video Input Connector 3	Connect from other component. (Video 3)
4	Audio Input Connector 3	Connect from other component. (Video 3)
5	TV GUIDE*	Press to display the TV GUIDE.
6	MENU*	Press to display Main Menu.

7	OK*	Press to select menu and sub-menu items.
8	TV/VIDEO*	Changes Input source.
9	VOL + / <<>*	Press to adjust TV sound and to navigate menus.
10	CH v^ / v^▲*	Press to change channels and to navigate menus.
11	Remote Control Sensor	Receives infrared signal from Remote Control.

* Buttons listed above operate the same as Remote Control buttons of the same name.

Rear View <Model PT-56DLX76 unit shown>

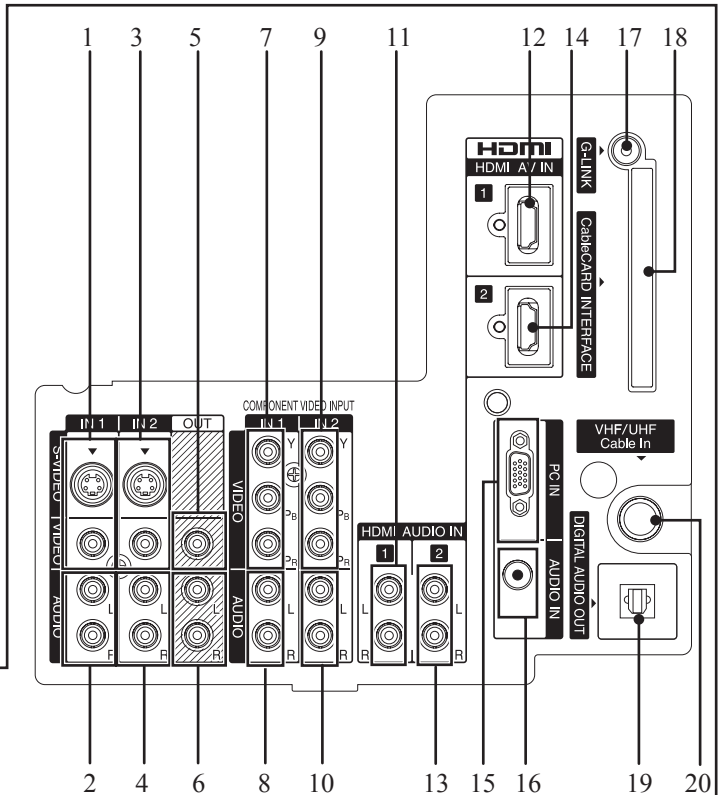
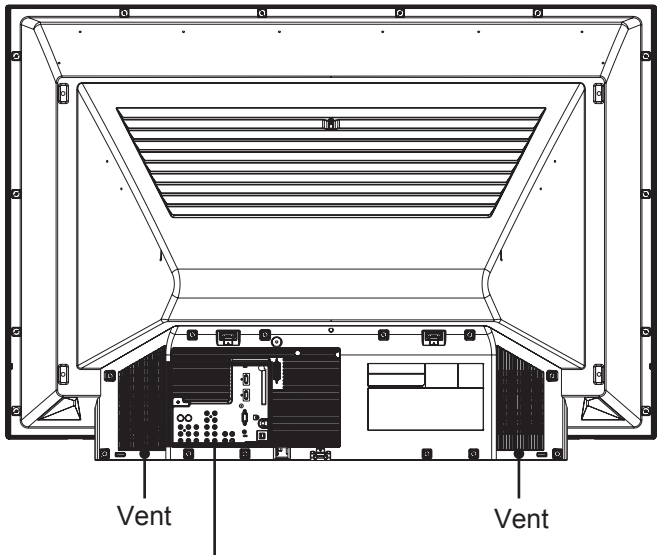

1	S-Video/Video Input Connector 1	Connect from other component. (Video 1)
2	Audio Input Connector 1	Connect from other component. (Video 1)
3	S-Video/Video Input Connector 2	Connect from other component. (Video 2)
4	Audio Input Connector 2	Connect from other component. (Video 2)
5	Video Out Connector	Output video signal.
6	Audio Out Connector	Output audio signal. (Analog)
7	Component Video Input Connector 1	Connect from other component. (Component 1)
8	Audio Input Connector 1	Connect from other component. (Component 1)
9	Component Video Input Connector 2	Connect from other component. (Component 2)
10	Audio Input Connector 2	Connect from other component. (Component 2)

11	HDMI Input Terminal 1	Audio 1	Connect from other component. (HDMI 1)
12		Audio/Video 1	Connect from other component. (HDMI 1)
13	HDMI Input Terminal 2	Audio 2	Connect from other component. (HDMI 2)
14		Audio/Video 2	Connect from other component. (HDMI 2)
15	PC (RGB) Input Connector		Connect from PC. (PC)
16	Audio Input Connector		Connect from PC. (PC)
17	G-LINK Connector		Connect the IR Blaster.
18	CableCARD™ INTERFACE		Insert CableCARD™.
19	DIGITAL AUDIO OUT		Output audio signal. (Digital)
20	VHF/UHF Cable In		Input terminal for an antenna or cable box signal.

Notes:

- Make sure the vents are not blocked. (This could cause damage.)
- Indication on the back panel may change without notice.

Installation

Notes on connections

- Turn off the power supply for all components before making any connections.
- Read the instruction manual for each system component carefully before connecting it.
- If there is a lot of jitter in the video signal input from the video source, the picture on the screen may flicker. In this case, it will be necessary to connect a TBC (time base corrector).

⚠ CAUTION

When using “Nut type” RF coaxial cable, tighten with fingers only. Overtightening may damage terminal.

Connecting the Antenna / Cable to the RF IN Terminal

Antenna Connection

For proper reception of digital and analog VHF/UHF channels, an external antenna is required. For best reception, an outdoor antenna is recommended.

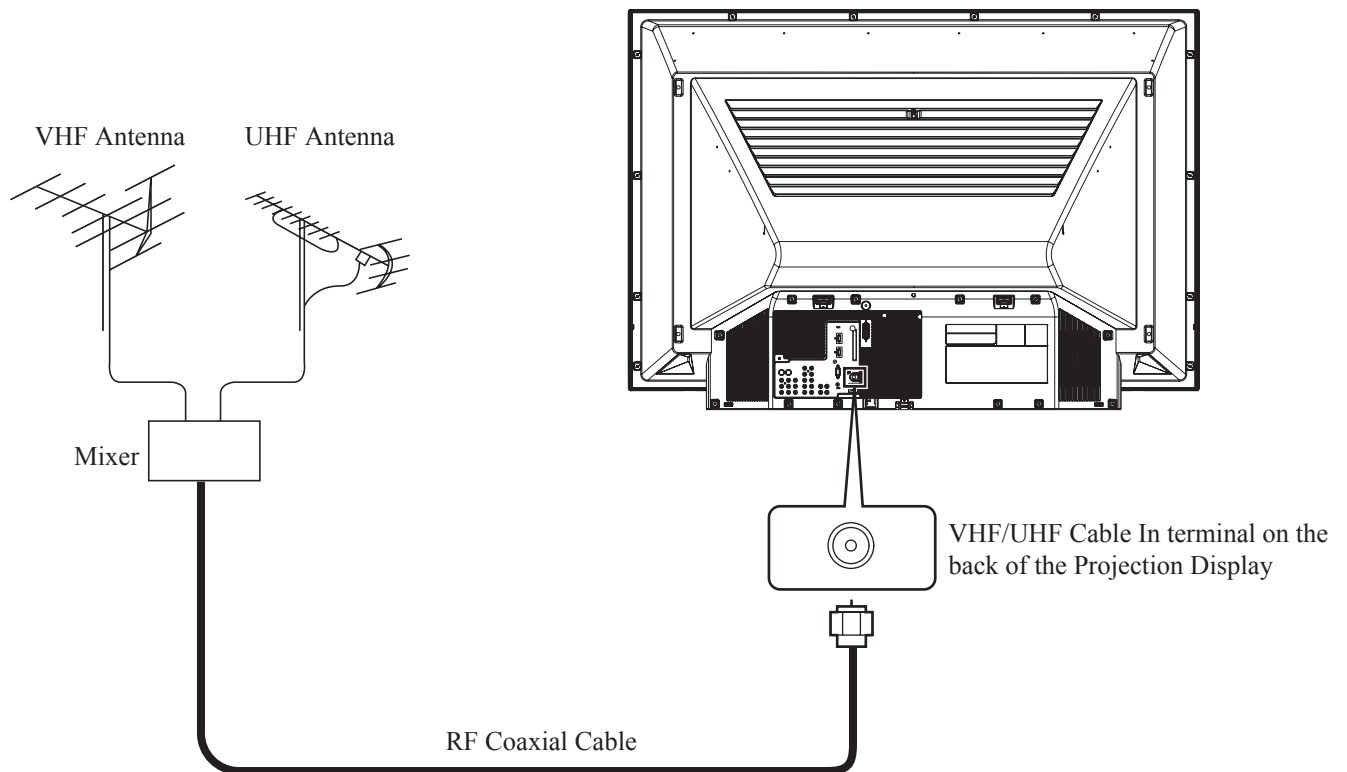

Cable Connection

For proper reception of analog or digital cable channels, a cable service connection is required.

Use this configuration when connecting the projection display to a cable TV system.

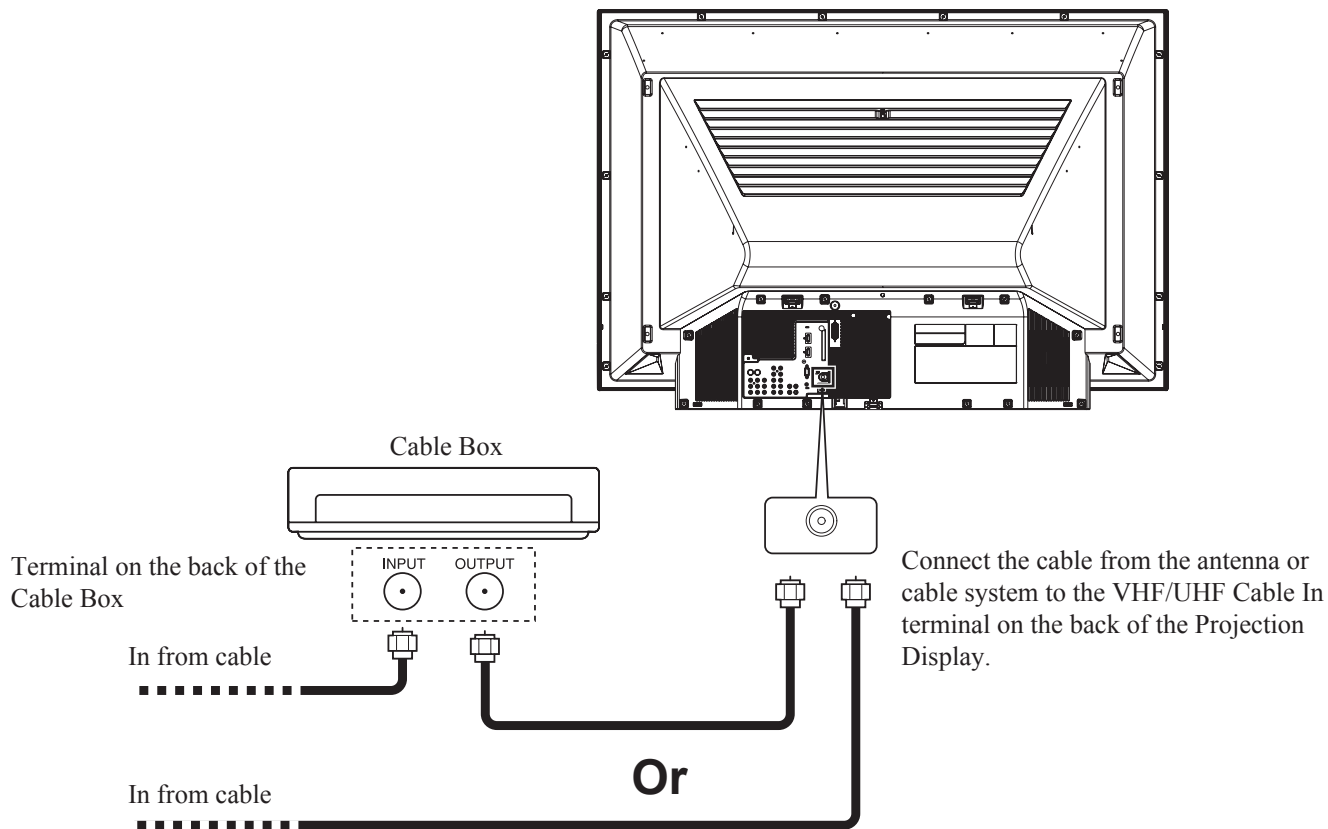

Notes:

- Certain cable systems offset some channels to reduce interference or have Premium (scrambled) channels. A cable converter box is required for proper reception. Check with your local cable company for its compatibility requirements.
- For reception of cable channels, connect the cable supplied by your local cable company.

Installation (continued)

CableCARD™ Connection

This module (also called Point of Deployment (POD) module or Digital Cable Module (DCM)) allows you to tune digital and high definition cable channels through the cable antenna. Contact your local cable company for information regarding the availability and costs of CableCARD™ related services.

- 1 Connect the cable antenna to VHF/UHF Cable In input on the back of the unit.
- 2 Insert the CableCARD™ (upper side facing right) into the CableCARD™ INTERFACE on the back of the unit.
 - Insert when Power is ON (green indicator light) and a MENU screen is not displayed.

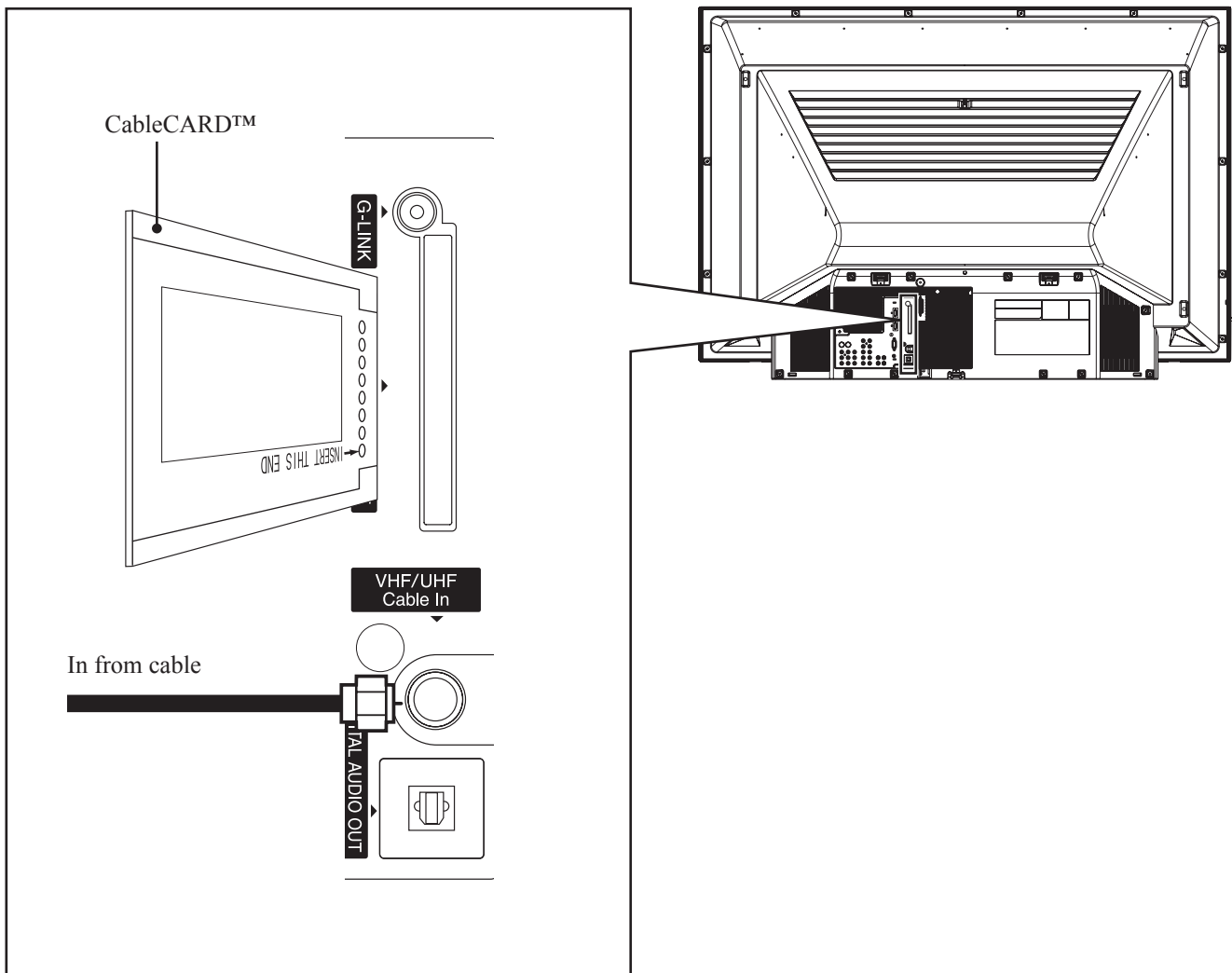

Notes:

- A Digital Cable Subscription is required.
- Do not insert a PC card into the CableCARD™ INTERFACE.
- Follow the instructions on screen.

If you experience keypad or remote control function hang-up when using CableCARD™, unplug the unit and plug it back in and try the controls again. If this condition still exists, please call Panasonic Customer Call Center for further instructions.

How to connect the “1, 2, 3” Input Terminals

Input 3 is located on the front of the unit. (p. 10)

Connect a VCR or other peripheral equipment

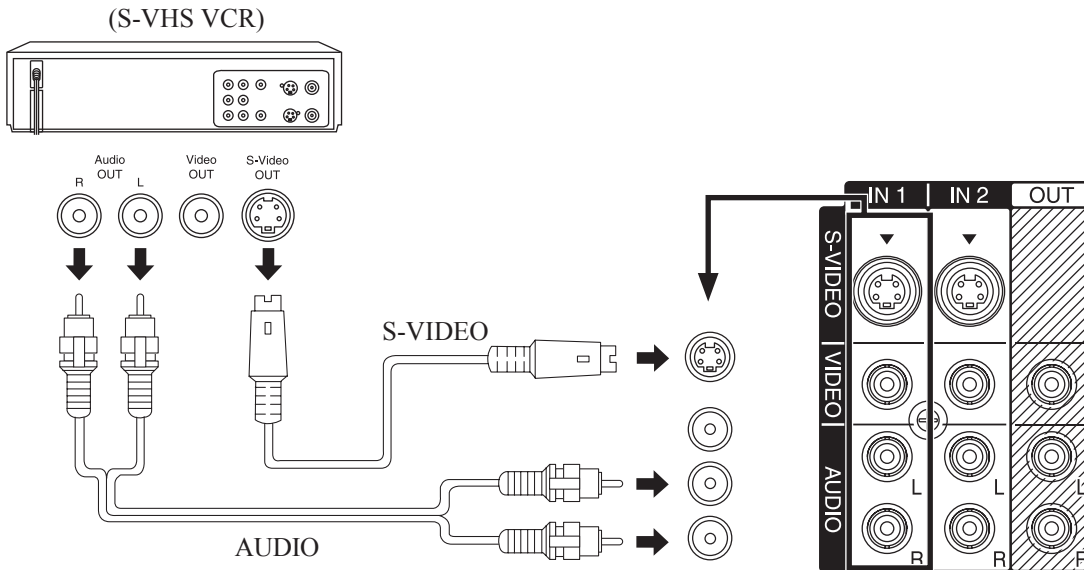

- Similar connections are available at the INPUT 1, 2, 3 input terminals. (p. 10-11)

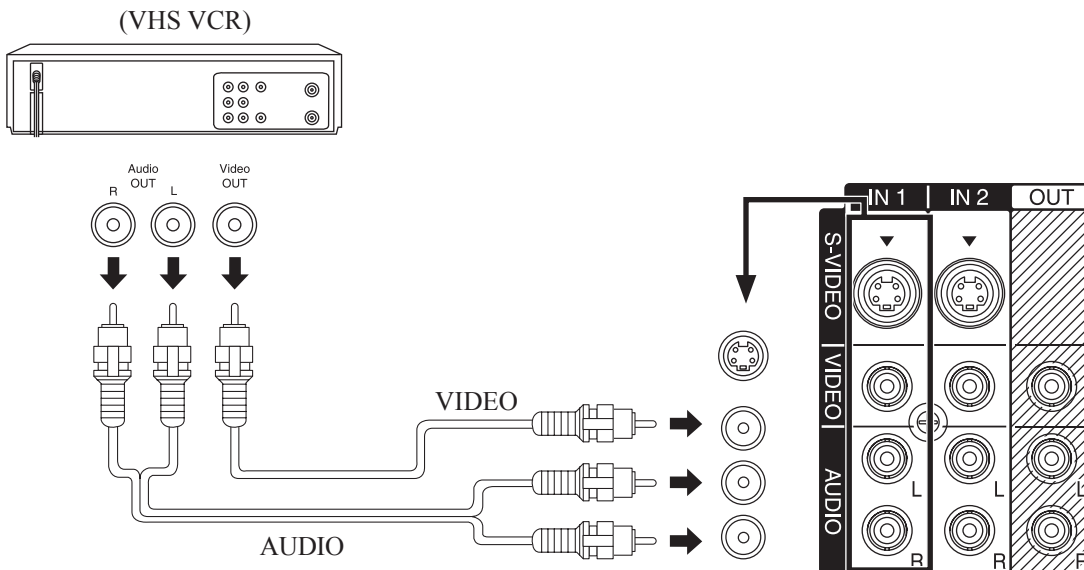

- Similar connections are available at the INPUT 1, 2, 3 input terminals. (p. 10-11)

Notes:

- Select the desired VIDEO input position by pressing the TV/VIDEO button. (p. 37)
- When connecting video cables, priority is given to the S-Video cable when the S-Video input terminal and the video input terminal are connected at the same time.

Installation (continued)

How to connect the COMPONENT VIDEO Input Terminals

Because each Y, P_B, and P_R signal is input independently, the Component signal allows for more accurate color reproduction.

The Component signal output terminal indication will differ according to the output device (Y, P_B, P_R). Please read the operating instructions included with the output device.

Connecting a DVD Player to COMPONENT VIDEO IN

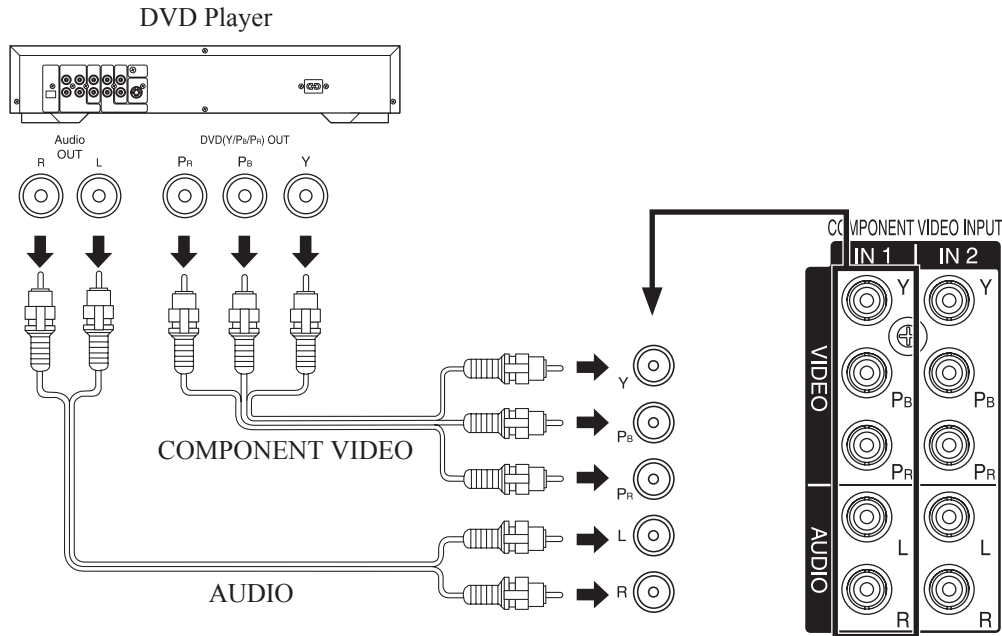

• Similar connections are available at the COMPONENT VIDEO INPUT 1-2 Terminals. (p. 11)

Notes:

- Select the desired COMPONENT VIDEO INPUT position by pressing the TV/VIDEO button. (p. 37)
- Component video signals that will be recognized are 480i, 480p, 720p, and 1080i.

Component Signals (Y, P_B, P_R) that can be Input

Mode type		Signal data		Information menu display
		No. of dots (H × V)	Vertical frequency (Hz)	
DTV Format Signals	480i	720 × 480	59.94/60.00	480i
	480p	720 × 480	59.94/60.00	480p
	720p	1 280 × 720	59.94/60.00	720p
	*1080i	1 920 × 1 080	59.94/60.00	1080i

Note:

- Input signal with a * mark will give you a more beautiful and stable picture than the other signals.

How to connect the AV OUT Terminals

You can connect a VCR to the AV OUT terminal to record the program you are viewing on-screen. An external monitor can also be connected to the AV OUT terminals. Connect the VCR as shown below.

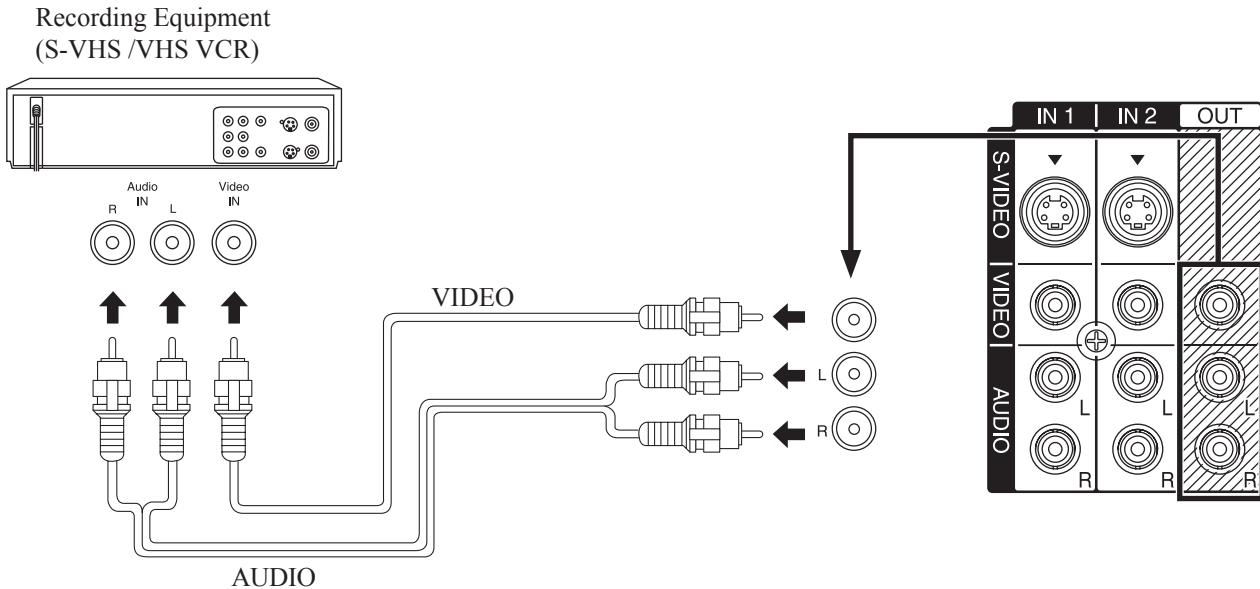

Notes:

- This unit contains Video and Audio Outputs for the purpose of recording television programming to VCR. Due to license restrictions, if a device (STB, DVD, etc.) is connected to the HDMI input of the unit, no video or audio output is allowed.
- AV OUT signal is available when receiving digital channel. However, all formats will be down converted to NTSC.
- Never connect the VIDEO IN and OUT terminals to the same video recorder, as this could cause incorrect operation.
- Even if unit is in Split mode, OUT terminals only output the main picture and sound signals. A sub-picture, etc., will not be output.
- AV terminals will not output COMPONENT VIDEO, PC/HDMI IN or SD card signals.
- Certain program content output from the AV OUT connector may have the copy protection modification applied to its signal, preventing VCRs from recording this video signal.

Installation (continued)

How to connect the Amplifier

Analog Audio Out

To listen to the audio through a separate stereo system, connect an external audio amplifier to **AUDIO OUT** on back of unit.

Stereo System
(A Stereo Amplifier and Speakers)

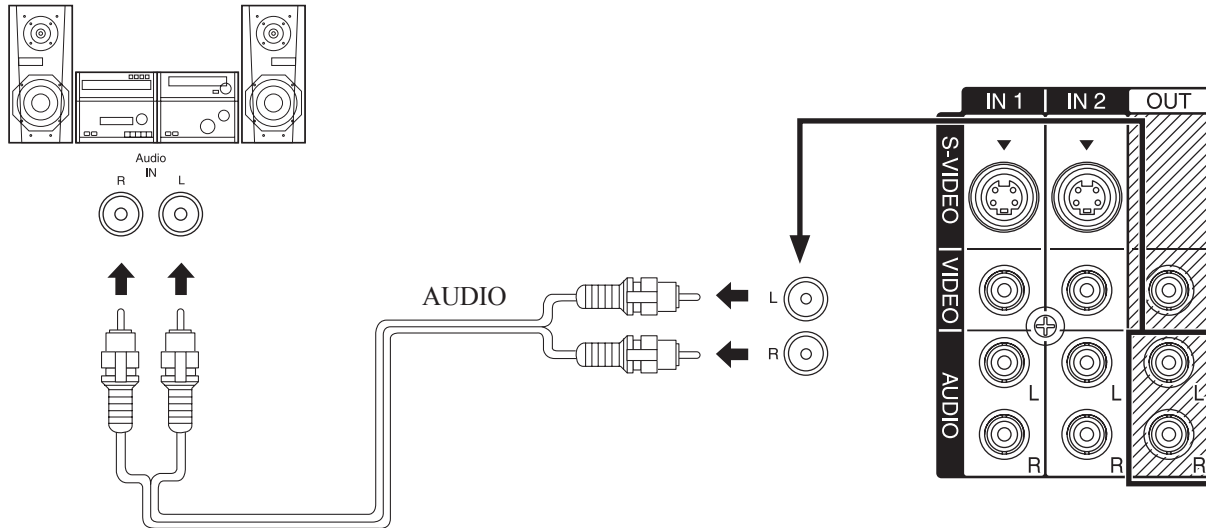

Audio Adjustments

- Select Speakers Off in Other adjust menu under Audio menu. (p. 48)
- Set amplifier volume to the preferred level.

Note:

- AUDIO OUT terminals cannot be connected directly to external speakers.

Digital Audio Out

Use the diagram below to connect the Digital Audio Output of your Projection Display to a Dolby Digital decoder.

Dolby Digital 5.1 channel surround sound delivers digital-quality sound. Dolby Digital provides five discrete full-bandwidth channels for front left, front right, center, surround left and surround right, plus a LFE (Low Frequency Effect) subwoofer channel. For a full Home Theater sound experience, an external Dolby Digital decoder and a multichannel amplifier must be connected to the Digital Audio Out jack on the unit.

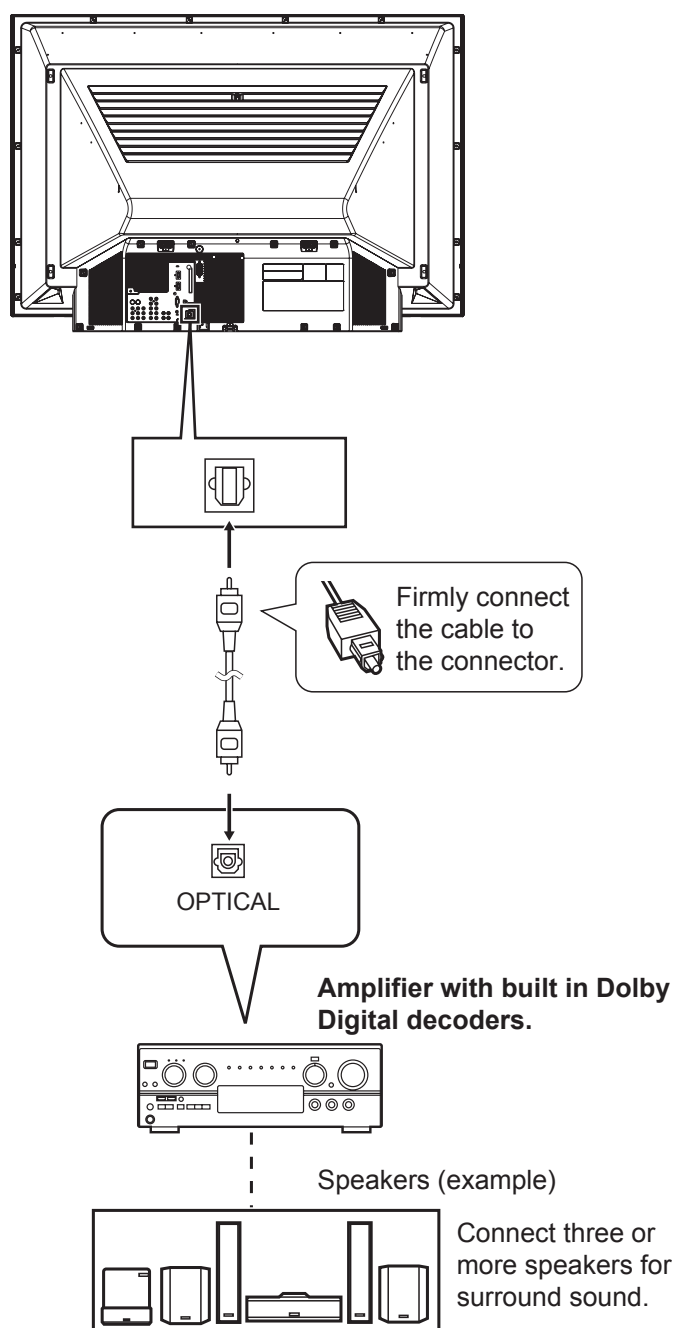

Procedure

Connect the Digital Audio cable from the Digital Audio Out jack on the unit to the Digital Audio In connection on the Dolby Digital decoder.

Notes:

- When ATSC channel is selected, the output from the Digital Audio Out jack will be Dolby Digital. But, if NTSC channel is selected, the output will be PCM.
- Depending on your DVD player and DVD-Audio software the copyright protection function may operate and disable optical output.

Installation (continued)

IR Blaster Connection

■ IR Blaster

Connecting the IR Blaster allows the Projection Display to send remote control signal commands to your VCR. This, along with the TV GUIDE feature on this set, lets you easily schedule recordings of digital programs. Place the signal-emitting area of the IR Blaster near the signal-receiving area for the Remote Control on the VCR.

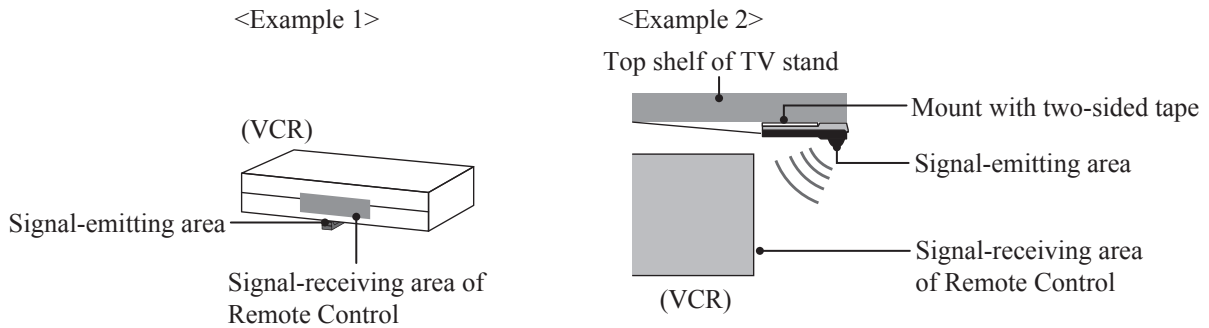

Note:

- To schedule a recording using TV Guide with IR Blaster, you must select Line-1 (L-1) on the VCR and then turn the VCR off. (Refer to the VCR Operating manual.)

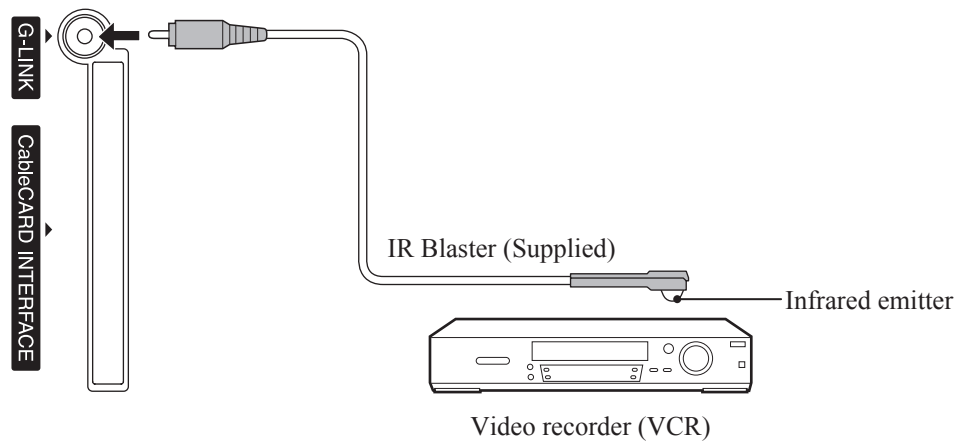

The TV acts as a proxy for some remote control operations of the VCR

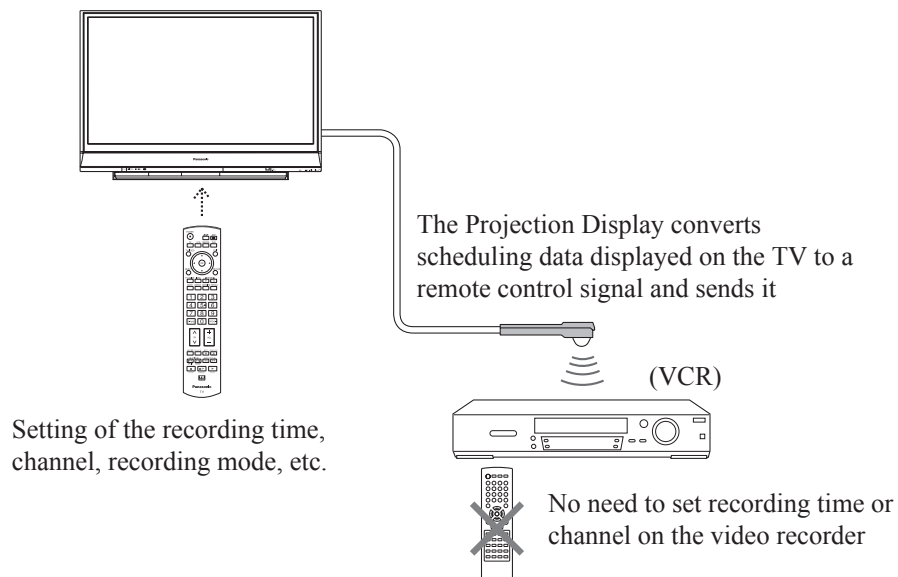

How to connect the HDMI input terminal

Recommended HDMI Connections

Follow the connection diagrams below for HDMI control of a single AV equipment such as a Panasonic DIGA-DVD recorder, RAM Theater or Player Theater system. Refer to page 68 for Setup Menu settings and additional control information.

- Optional HDMI and/or optical cables are not provided.

If connection (or setting) of equipment compatible with HDMI control is changed, switch the power of this unit Off then On again while the power of all equipment is On (to this unit to correctly recognize the connected equipment) and check that DIGA, RAM theater and Player theater playback operates.

■ Connecting this unit to a DVD recorder, RAM theater or Player theater

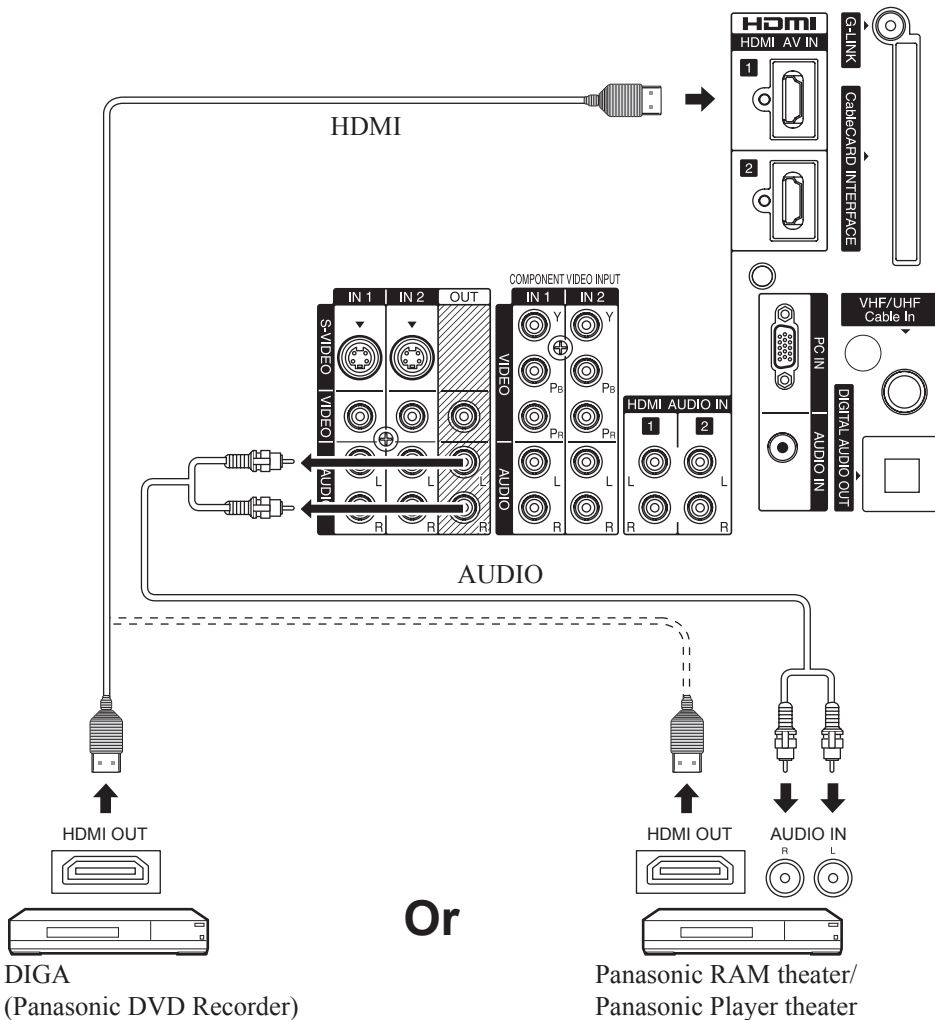

- For DIGA:
 - Connect with HDMI cable.
- For RAM theater and Player theater:
 - Connect with HDMI cable and audio cable.
 - Connect this unit's AUDIO OUT (L&R) to listen to the TV program through the theater system.

Note:

- HDMI 1 is recommended. When connecting to HDMI 2, set the input mode to HDMI 2 (p. 37) initially before connecting to HDMI 2. After connection, confirm the HDMI control functions (p. 68-69).

■ Setting this unit after connections

After making connections as shown above, set "Ctrl with HDMI" (under "Other adjust") first to "Off" and then "On" using the Setup Menu. (p. 68)

Installation (continued)

■ Connecting this unit to a DVD recorder and AV amp

When using an “Control with HDMI” audio-video amplifier and a compatible DIGA recorder, use a daisy chain connection as shown below.

- One AV amp and one DIGA can be operated with this unit.
- Be sure to connect the AV amp between this unit and the DIGA.

Note:

- HDMI 1 is recommended. When connecting to HDMI 2, set the input mode to HDMI 2 (p. 37) initially before connecting to HDMI 2. After connection, confirm the HDMI control functions (p. 68-69).

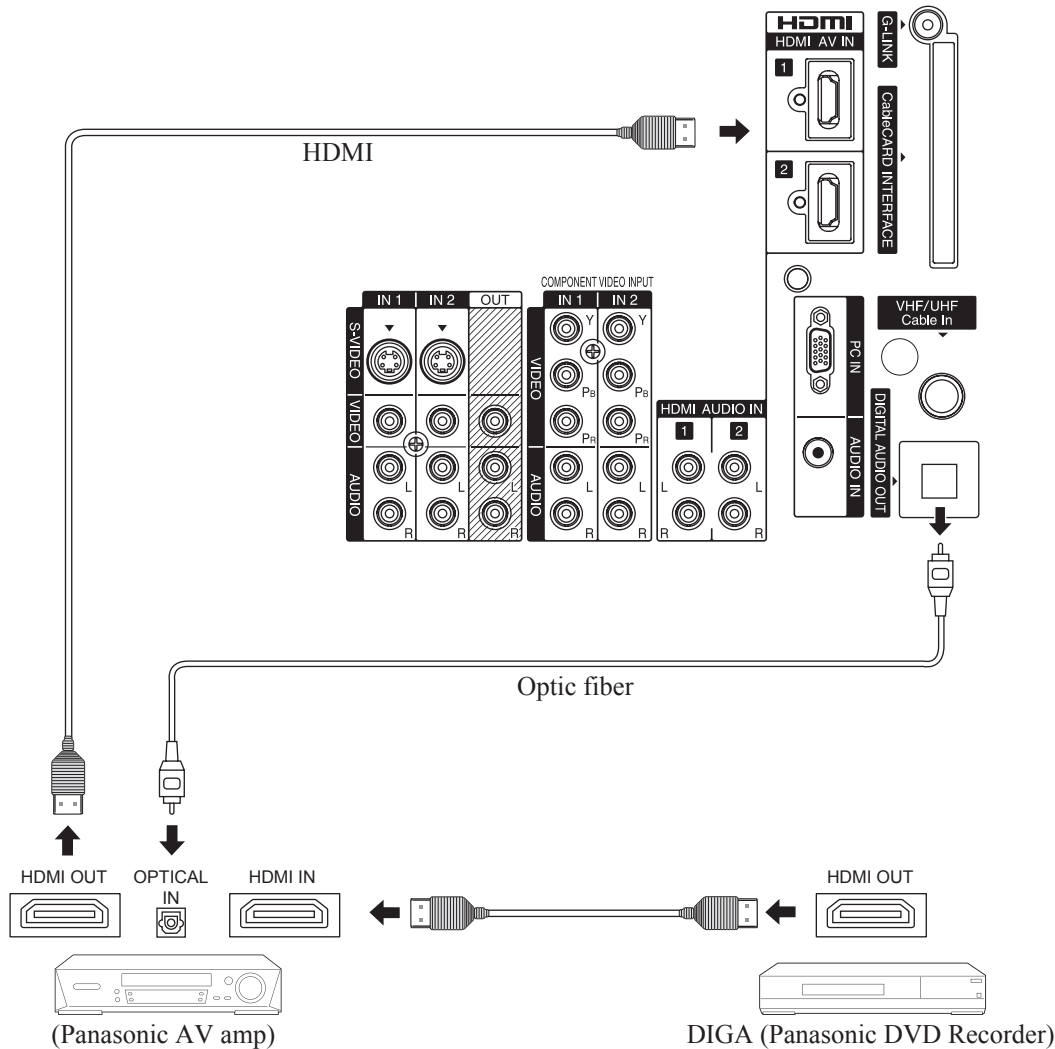

■ Setting this unit after connections

After making connections as shown above, set “Ctrl with HDMI” (under “Other adjust”) first to “Off” and then “On” using the Setup Menu. (p. 68)

Notes:

- Individual HDMI devices may require additional menu settings specific to each model. Please refer to their respective operating instruction manuals.
- When audio from other equipment connected to this unit via HDMI is output using “DIGITAL AUDIO OUT” of this unit, the system switches to 2CH audio.
(When connected to an AV amp via HDMI, you will enjoy higher sound quality.)
(Current as of March 2006)
- We recommend using Panasonic HDMI cables RP-CDHG15 (1.5 m), RP-CDHG30 (3.0 m), RP-CDHG50 (5.0 m), etc.
(Product numbers correct as of January 2006.)
- The Panasonic 7 m cable (RP-CDHG70) is compatible with 1080i format. (When the 1080p format is displayed, we do not recommend using this cable.)

Procedure

- 1 Connect the HDMI output on the DVD Recorder or Set Top Box, etc., to the HDMI input on the back of the unit.
 - If you cannot display the picture because your Digital Set Top Box does not have a Digital Out terminal setting, use the Component Video Input (or the S-Video Input or Video Input). In this case, the picture will be displayed as an analog signal.
- 2 Press TV/VIDEO to select HDMI input.

By inputting a High-bandwidth Digital Content Protection high-definition picture source to the HDMI IN terminals of this Projection Display, high-definition pictures can be displayed on the screen in their digital form. (This terminal is for use with HDMI equipped DVD players, Set top boxes and D-VHS machines.)

Notes:

- Select the HDMI input position by pressing the TV/VIDEO button. (p. 37)
- The HDMI IN terminals can only be used with 1080i, 1080p, 720p, 480p and 480i picture signals.
- If there is no audio, check if the source equipment has PCM output. If not, please use analog connections.
- Be sure HDMI is securely connected. If not, picture noise and/or incorrect picture display may result.
- With HDMI connection, depending on the signal, the picture may be displayed with unnatural colors (as if red and blue are reversed). Refer to "Color corr." on page 46.
- If the external device has only a DVI output, connect to the HDMI terminal via a DVI to HDMI adaptor cable*1.
- When the DVI to HDMI adaptor cable*1 is used, connect the audio cable to the audio input terminal.

*1 Enquire at your local digital device retailer shop.

Compatible formats

Video Signal:

The Projection Display is compatible with following formats. Please set the connected device to following one of the formats.

Display mode	No. of dots	Vertical scanning frequency (Hz)	Information menu display
480i	720 × 480	59.94 / 60	480i
480p	720 × 480 640 × 480	59.94 / 60 59.94 / 60	480p
720p	1 280 × 720	59.94 / 60	720p
1080i	1 920 × 1 080	59.94 / 60	1080i
1080p*	1 920 × 1 080	59.94 / 60	1080p

* If the image is displayed incorrectly, please change the resolution setting of the source device to another format.

* When a 1080p (HDMI) signal is received, the Main Menu screen cannot be displayed. However, the Picture Menu screen (Normal, Pic. mode, Picture, Brightness, Color, Tint, Sharpness, and Color temp) can be displayed. (p. 44)

Audio signal (PCM)

When digital audio is included in the HDMI connection, the compatible sampling frequencies are 48 kHz/44.1 kHz/32 kHz. Refer to "HDMI1 in" or "HDMI2" in on page 48.

About HDMI

HDMI is the first all digital consumer electronics A/V interface that supports several uncompressed standards, enhanced and high definition video formats as well as all existing multi-channel audio formats. One jack supports both video and audio information. The HDMI/HDCP*1 input can be connected to an EIA/CEA 861/861B*2 compliant consumer electronic device, such as a set top box or DVD player equipped with a HDMI output connection. By inputting a High-bandwidth Digital Content Protection (HDCP) high definition picture source to the HDMI terminal of this unit, high definition pictures can be displayed on the screen in their digital form. The HDMI input terminal is not intended to be used with personal computers. This unit is compatible with 1080i, 1080p, 720p, 480p and 480i formats. Select the output of the connected device to match that of the unit.

Notes:

*1 HDMI/HDCP = High Definition Multimedia Interface / High-Bandwidth Digital Copy Protection.

*2 EIA/CEA-861/861B Profiles compliance covers profiles for transmission of uncompressed digital video including high bandwidth digital content protection.

Installation (continued)

How to connect the PC IN Terminals

Connecting a PC to PC IN

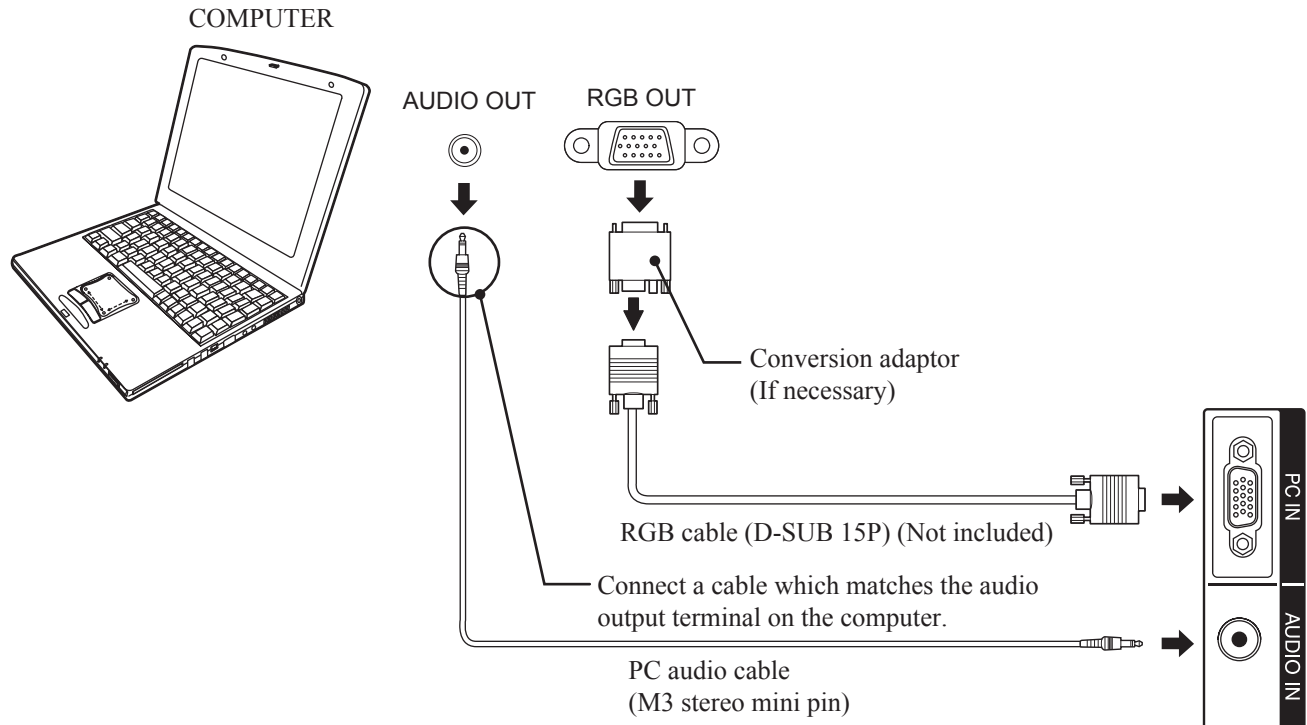

PC IN Terminal (D-SUB 15P) Pin Layouts

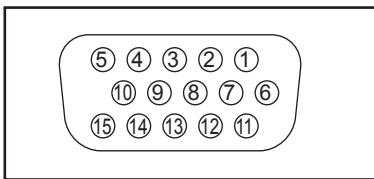

Connection port view

Pin No.	Signal name
1	R
2	G
3	B
4	NC
5	NC
6	Ground for R
7	Ground for G
8	Ground for B

Pin No.	Signal name
9	NC
10	Ground
11	NC
12	NC
13	HD/CSYNC
14	VD
15	NC

NC: Not connected

Notes:

- Some PC models cannot be connected to the set. A conversion adaptor is required to use the RGB cable (D-SUB 15P) (Not included) to connect a Macintosh computer to the set. There is no need to use an adaptor for computers with PC / AT compatible D-SUB 15P terminal.
- The computer shown in the illustration is for example purposes only. Additional equipment and cables shown are not supplied with this set.
- Do not set the horizontal and vertical scanning frequencies for PC signals which are above or below the specified frequency range.
- Select the desired PC input position by pressing the TV/VIDEO button. (p. 37)

RGB signals that can be input

The table below lists the different types of RGB signals that can be input.

If a signal which differs greatly from the types listed below is input, the picture may not be displayed correctly, or a black background may be displayed.

Mode type		Signal data		
		No. of dots (H × V)	Horizontal frequency (kHz)	Vertical frequency (Hz)
Personal Computer Signals	VGA400 (70 Hz)	640 × 400	31.47	70.08
	* VGA480 (60 Hz)	640 × 480	31.47	59.94
	Macintosh 13"	640 × 480	35.00	66.67
	VGA480 (75 Hz)	640 × 480	37.50	75.00
	* SVGA (60 Hz)	800 × 600	37.88	60.32
	SVGA (75 Hz)	800 × 600	46.88	75.00
	SVGA (85 Hz)	800 × 600	53.67	85.06
	Macintosh 16"	832 × 624	49.73	74.55
	* XGA (60 Hz)	1 024 × 768	48.36	60.00
	XGA (70 Hz)	1 024 × 768	56.48	70.07
	XGA (75 Hz)	1 024 × 768	60.02	75.03
	* WXGA (60 Hz)	1 280 × 768	47.78	59.87

Notes:

- A vertical frequency of 60 Hz (signal with a * mark) is recommended.
- To view a WXGA picture, a setting change is necessary. Please refer to "PC Adjust" on page 45.
- The D-SUB 15P connector can accept RGB (H-V sync separate).
- When an external video processor/scaler is used, it must have RGB (H-V sync separate) output.

Power ON / OFF

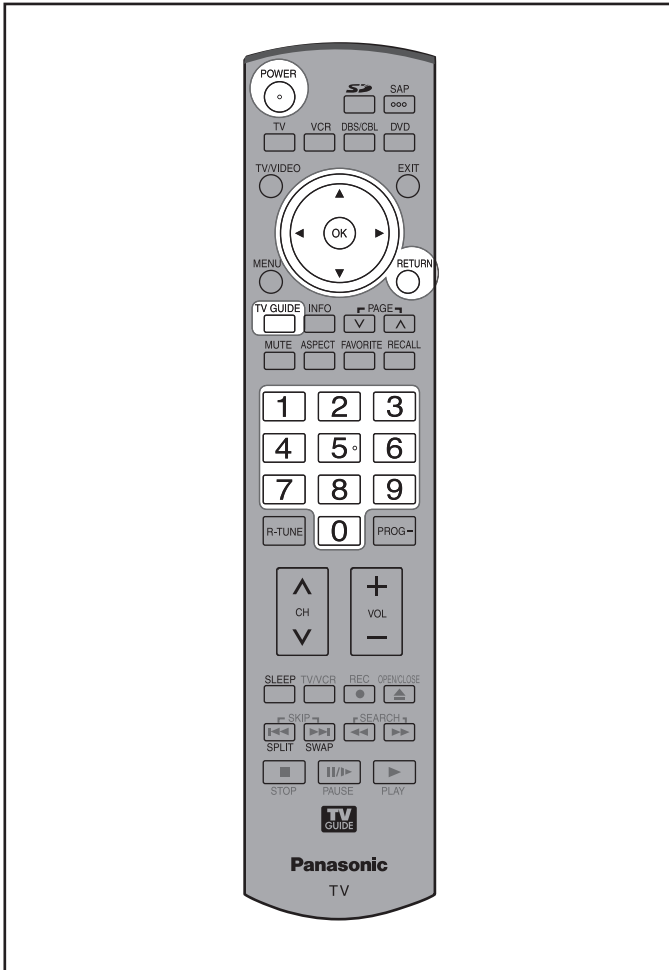

Turning the Power ON and OFF

Always be sure to follow the procedure given below to turn the Projection Display power ON and OFF.

- The lamp cooling fan will continue to operate for approximately 1 minute after the power is turned off. During this time, the POWER indicator will blink Red.

Do not disconnect the power cord from the outlet and do not open the circuit breaker (unless necessary) while the cooling fan is still operating. Do not disconnect the power cord from the power outlet while the power indicator blinks Red.

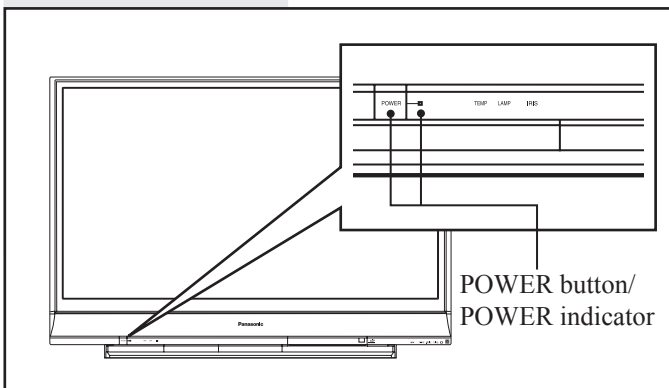

The Power Indicator

LED	ACTION
Off	Power – OFF
Red (blinking)	Power – OFF (Now cooling)
Green	Power – ON
Green (blinking)	Power – ON (Preparing to light lamp)

Notes:

- If the POWER button is accidentally turned off during use, after power is turned back on, it may take a short period before the lamp automatically comes on.
- After the unit is turned on, maximum picture brightness and color will be achieved in 5-10 minutes. During this time, brightness and color levels may change. This is normal.
- This unit consumes approx. 0.5 W (13 W when CableCARD™ is inserted.) in OFF condition when plugged into an AC outlet.

Power ON

Press POWER on Projection Display or Remote Control to turn power on.

The Power Indicator blinks Green for about 15 seconds and then turns solid Green.

Power OFF

Press POWER on Projection Display or Remote Control to turn power off.

Power shuts off after a Black Screen is displayed for a few seconds.

Note:

- If the POWER button is pressed during the Black Screen display, Power is turned back on.

The Power Indicator blinks Red for about 1 minute and then LED turns off.

Note:

- When the power cord is disconnected, the internal cooling fan stops operating. In this case, the lamp will be insufficiently cooled and will take a while to turn ON again.

Auto shut off

To conserve lamp life, if there is no signal to the set's tuner for 5 minutes, the lamp will shut off automatically.

First Time Setup

For your convenience, First Time Set up menu will be displayed on screen when the set is turned on for the first time. If needed, follow the menus and procedures displayed on-screen for setting up the features.

Language

The language of the on-screen display is set to English as the factory setting. You can select English, Spanish or French as the on-screen displays language.

1

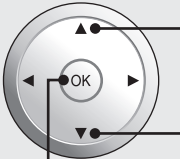

Press to select "Language".

Press to display Language screen.

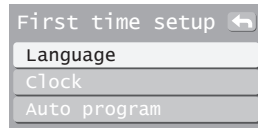

2



Press to select "English," "Español" or "Français".

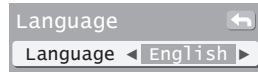

3



Press to go to previous screen. Or, select icon, then press OK for same results.

Clock

You can adjust the Date and Time.

1

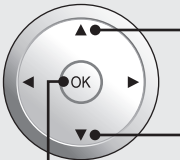

Press to select "Clock".

Press to display Clock screen.

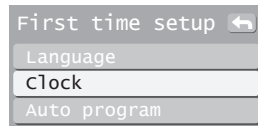

2



Press to select "Date".

Press to adjust the date.

- Press and hold to change the month.

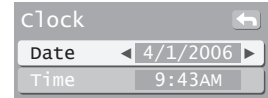

3



Press to select "Time".

Press to adjust the time.

- If the button is held, the speed of change increases.

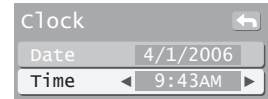

4



Press to go to previous screen. Or, select icon, then press OK for same results.

Auto program

You can scan All (Analog and Digital) channels. If needed, follow the menus and procedures displayed on-screen for setting up the features. You can also make the settings in Setup menu.

1



Press to select "Auto program".

Press to display Auto program screen.

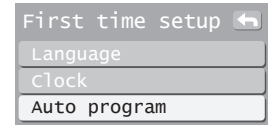

2



Press to select "ANT In".

Press to select "Cable" or "Antenna".

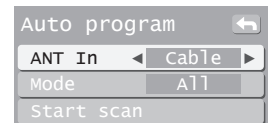

Power ON / OFF (continued)

3  Press to select Mode.
Press to select "All" or "Analog".

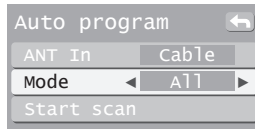

4  Press to select "Start scan".
Press to start.
Channels available for reception will be set automatically.

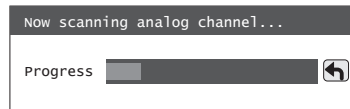
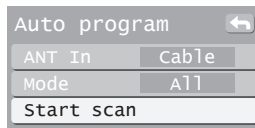

5 After Auto program is complete, the unit will return to Manual program mode. To place the channels that were located by auto scan in memory, move the cursor to "Apply" and press OK. (p. 34-36)
If OK is not pressed after selecting APPLY, the channels will not be memorized.

Notes:

- After "Auto program" is completed the unit tunes to the first channel found during "Auto program".
- If setup is incomplete, check connection of Antenna/Cable to the RF IN Terminal, then try "Auto program" again. (p. 33-34)
- "Auto program" must be done when you select the input signal for the first time or whenever you change the antenna configuration.
- Depending on conditions, "Auto program" may take a while.

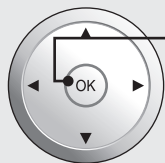
6  Press to start Initial Guide Setup for TV Guide.



Follow the instructions on the screen to perform setup. (p. 58-63)

INITIAL GUIDE SETUP for TV Guide

The TV Guide Welcome Screen is displayed when you use TV Guide function for the first time, or at first time setup. (p. 27)

■ Procedure

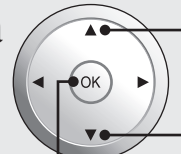
a  Press to select each item.
Press to set.

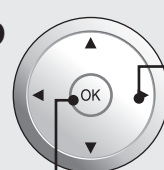
b  Press to select "Next".
Press to display the next setting screen.

1 Identify Your Location

The Guide uses setup information to provide TV show listings and channel lineups for your area.

1 Select your country.

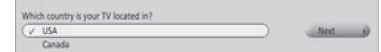

2 

Press the NUMBER keys or ▲▼ to enter a ZIP Code or Postal Code.



Or



2 Select Your Service(s)

Select the connected video source(s) for which you would like to receive show listings.

- If you do not have cable or satellite service, you must select Antenna in order to receive a channel lineup and listings.



3 Configure Your Service(s)

For each service you chose in Step 2, you are asked to select the corresponding input. Additional setup screens appear based on the types of service(s) you selected.

4 Check Your Settings

After you have configured all services you selected in Step 2 you are asked to check your settings.



- If you select “Yes, continue setup process”, go to Step 5.
- If you select “No, repeat setup process”, return to Step 1.

5 Configure Your VCR

If you want to use TV Guide On Screen Listings to schedule recordings to your VCR, answer “Yes, set up VCR control”.

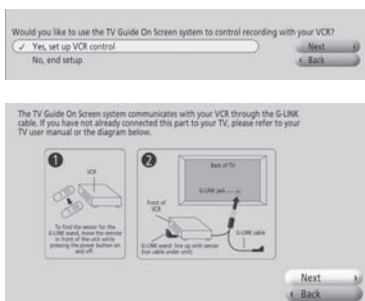

- For more on IR Blaster Connection, refer to “IR Blaster Connection” on page 20.

Additional screens ask you to

- Confirm remote control options.
- Confirm the external connections.
- Select the VCR brand.
- Test and confirm the remote code.

If you do not want the Guide to control recording to your VCR, answer “No, end setup” and go to Step 6.

6 Complete Setup

The Helpful Information screen displays when you successfully complete Guide setup.

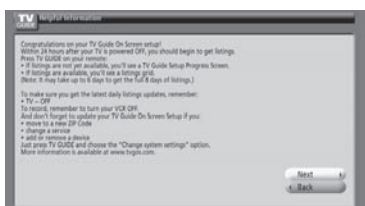

View Setup Progress Screen



Press to view setup progress screen.

- The setup progress screen appears each time you enter the Guide prior to receiving your initial eight days of show listings. To close the screen, press ◀ or OK.

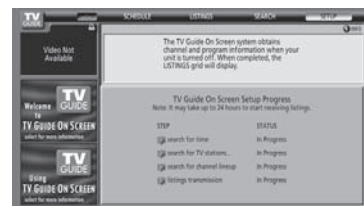

Caution:

- In order to begin receiving listings, turn the TV off when not in use. Within 24 hours, you will begin to receive TV show listings. It may take up to six days to receive the full eight days of initial show listings.

To not have TV Guide displayed when power is turned on

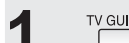

Press to view TV Guide.



Press to select “SETUP”.

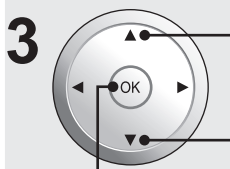

Press to select “Change default options”.

Press to display the CHANGE DEFAULT OPTIONS menu.

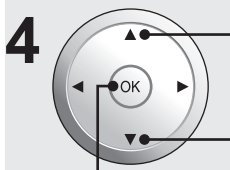

Press to select “General defaults”.

Press to display the General Defaults menu.

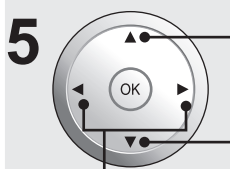

Press to select “auto guide”.

Press to select “off”.

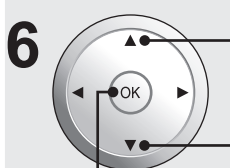

Press to select “done”.

Press to complete the settings.

Basic Menu Navigation



Button operation during Menu display (Menu navigation)

Return to Main Menu.

Press to display Main menu.

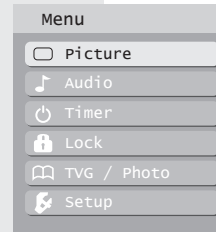

(PC input menu)



Note:

- While Main Menu (only) is displayed, pressing MENU will exit the menu screen.

Return to previous level menu.

Press to return to previous level menu.

Example:

If RETURN is pressed from Adv. adjust Menu:

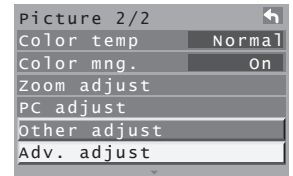
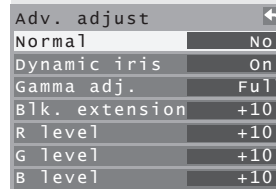

Return to normal picture.

Press to exit menu.



Pressing MENU displays the Main Menu screen.

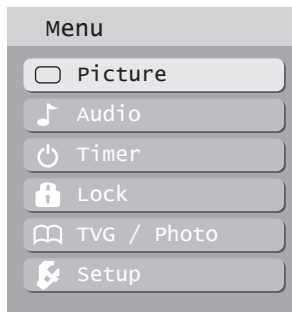

(PC input menu)



- Depending on the signal being input, some items may or may not be adjustable and some functions may or may not be available.
- When a 1080p (HDMI) signal is received, the Main Menu screen cannot be displayed. However, the Picture Menu screen (Normal, Pic. mode, Picture, Brightness, Color, Tint, Sharpness, and Color temp) can be displayed. (p. 23, 44)

Example of a procedure

1



Press to select the desired icon.

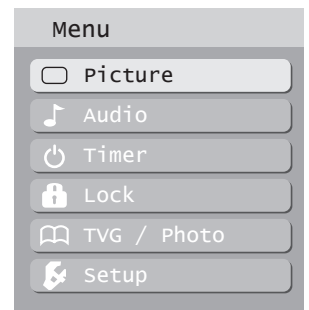

2  Press to enter the menu.

Picture 1/2		↩
Normal	No	
Pic. mode	Vivid	
Picture	+10	
Brightness	+10	
Color	+10	
Tint	+10	
Sharpness	+10	

3  Press to select desired menu item.

Picture 1/2		↩
Normal	No	
Pic. mode	Vivid	
Picture	+10	
Brightness	+10	
Color	+10	
Tint	+10	
Sharpness	+10	

Next Icon



Picture 2/2		↩
Color temp	Normal	
Color mng.	On	
Zoom adjust		
PC adjust		
Other adjust		
Adv. adjust		

Sub Menu Field

A Next Icon means there are more menu items to view.

4  Press to adjust or set desired menu item.

color	+5	
-------	----	--

Other Adjust sub-menu.

5  Press to select "Other adjust".

Picture 2/2		↩
Color temp	Normal	
Color mng.	On	
Zoom adjust		
PC adjust		
Other adjust		
Adv. adjust		

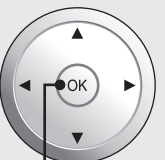
6  Press to access Other adjust sub-menu.

Other adjust		↩
Video NR	On	
3D Y/C filter	On	
Color matrix	SD	
MPEG NR	On	
Black level	Light	
3D I/P	On	
Color corr.	On	

7  Press to select desired sub-menu items.

Other adjust		↩
Video NR	On	
3D Y/C filter	On	
Color matrix	SD	
MPEG NR	On	
Black level	Light	
3D I/P	On	
Color corr.	On	

8  Press to adjust or set desired menu item.

Other adjust		↩
Video NR	On	
3D Y/C filter	On	
Color matrix	SD	
MPEG NR	Off	
Black level	Light	
3D I/P	On	
Color corr.	On	

Tuning channels

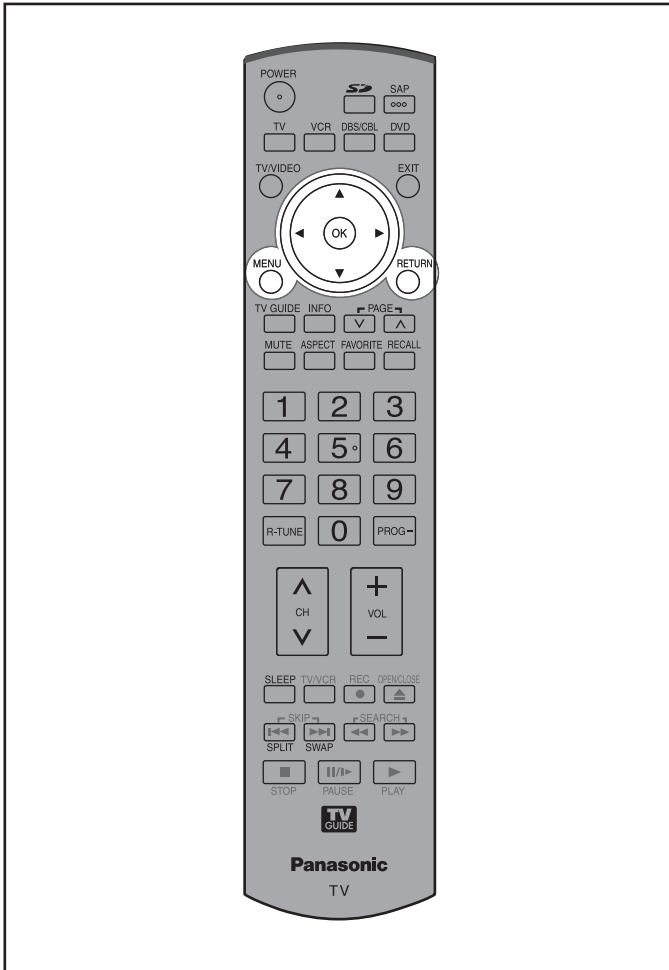

2 Press to select "Language".

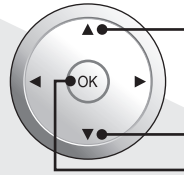

Press to display Language screen.

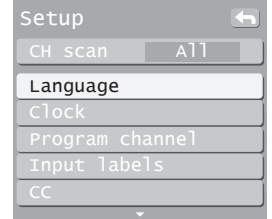

3 Press to select "English," "Español" or "Français".

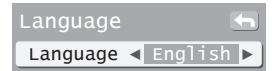

4 Press to go to previous screen. Or, select  icon, then press OK for same results.



Switching languages for display

Allows you to select the language used for On Screen Displays.

Press MENU to display the Main Menu screen.

1 Press to select "Setup" icon.
Press to display the Setup menu.

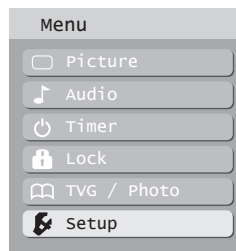
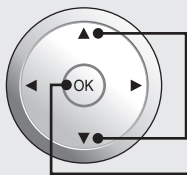

Clock Setting

You can adjust the Date and Time.

Press MENU to display the Main Menu screen.

1 Press to select "Setup" icon.
Press to display the Setup menu.

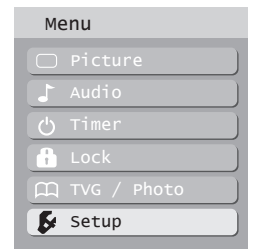
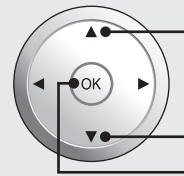

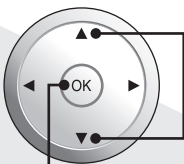
2  Press to select "Clock".
 Press to display Clock screen.

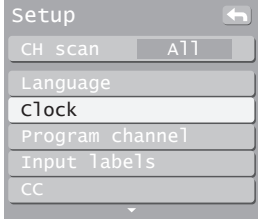

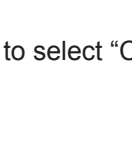
3  Press to select "Date".
 Press to adjust the date.
 • Press and hold to change the month.

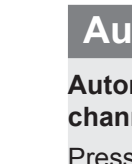

4  Press to select "Time".
 Press to adjust the time.
 • If the button is held, the speed of change increases.

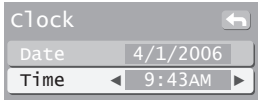

5  Press to go to previous screen. Or, select ← icon, then press OK for same results.

Automatic program setting

Automatically searches and adds receivable channels to memory.

Press MENU to display the Main Menu screen.

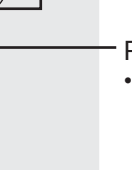
1  Press to select "Setup" icon.
 Press to display the Setup menu.

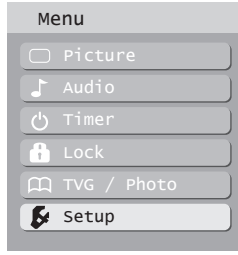

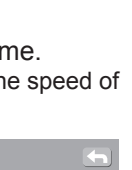
2  Press to select "Program channel".
 Press to display the Program channel menu.

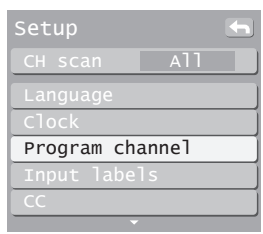

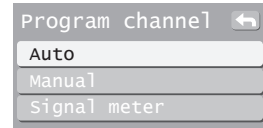

3  Press to select "Auto".
 Press to enter the Auto menu.



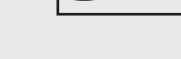

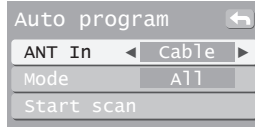
Tuning channels (continued)

- 4**  Press to select "ANT In".
-  Press to select "Antenna" or "Cable".

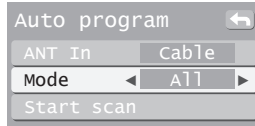

- 5**  Press to select "Mode".
-  Press to select "All" or "Analog".

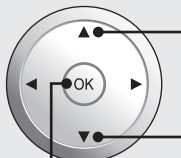

- 6**  Press to select "Start scan".
-  Press to start Scan.

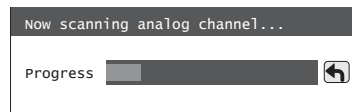

- 7** After Auto program is complete, the unit will return to Manual program mode. To place the channels that were located by auto scan in memory, move the cursor to "Apply" and press OK. (p. 34-36)
If OK is not pressed after selecting APPLY, the channels will not be memorized.

Notes:

- If "Cable" or "Antenna" is selected and a CableCARD™ is not inserted, Auto program will perform Scan All.
- If "Cable" is selected and a CableCARD™ is inserted, Auto scan will not be available.
- Some channels with very weak signals may be locked into memory. If desired, these channels can be deleted manually using the "Manual program setting". (p. 34)
- "Auto program" must be done when you select the input signal for the first time or whenever you change the antenna configuration.



Manual program setting

Use this procedure when changing setting of receiving channels or changing the channel display. Also, use to add or delete channels from channel list manually.

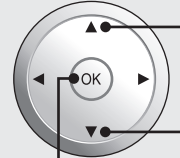
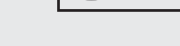

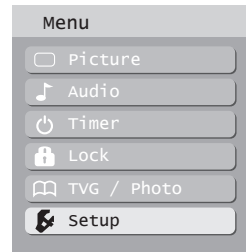
Press MENU to display the Main Menu screen.

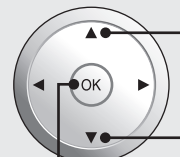
- 1**  Press to select "Setup" icon.
-  Press to display the Setup menu.

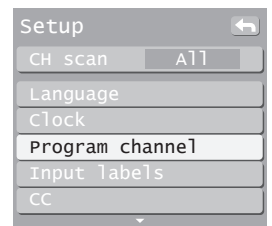

- 2**  Press to select "Program channel".
-  Press to display the Program channel menu.

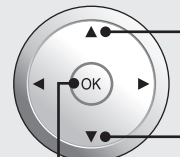

- 3**  Press to select "Manual".
-  Press to enter the Manual program screen.

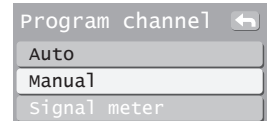

Note:

- If Lock (p. 50) has been set, you must enter your password to display the Manual Program screen.

- 

Press to select "Edit".



Press to enter the edit mode.

CH	Caption	Favorite	Add
1	---	---	No
2	---	---	No
3	---	---	No
4	---	---	No
5	---	---	No
6	---	---	No
7	---	---	No
8	---	---	No
9	---	---	No
10	---	---	No

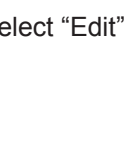
- 

Press to select the desired preset channel line.



Press to select edit area. "CH," "Caption," "Favorite," "Add".

■ Edit (Caption)

When a preset Caption has been entered.

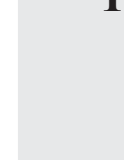
- 

Press to enter the Caption select screen.
- 

Press to select "Preset".

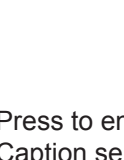

Press to select Broadcast station.
- 

Press to move cursor to "Apply".

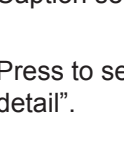

Press to enter the Caption.

Caption select	Apply	←
Preset	←	---
Caption detail		

When selecting a desired Caption manually.

- 

Press to enter the Caption select screen.
- 

Press to select "Caption detail".

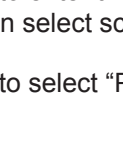

Press to display the Caption input screen.
- 

Press to move cursor to "Caption".

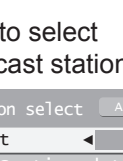



Press to enter input field.

Caption detail	Apply	←
Caption	---	---

- 

Press to select the character to input/change.

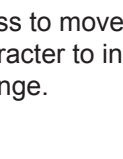

Press to move to the character to input/change.
- 

Press to enter your selection.
- 

Press to move cursor to "Apply".

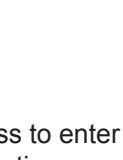

Press to enter the Caption.

Tuning channels (continued)

■ Edit (Favorite)

1  Press to enter the Favorite screen.

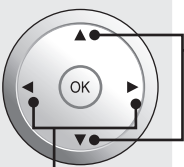
2  Press to select "Favorite".

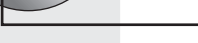
 Press to select Favorite number.

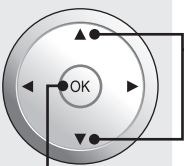

3  Press to move cursor to "Apply".

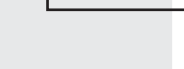
 Press to enter Favorite and return to Edit screen.

■ Edit (Add)

Setting of register/delete in Program channel.

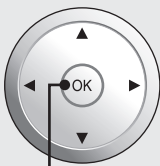
 Press to select "Yes" or "No".

■ Preview (CH)

You can display a program by selecting it in the small window at the top left of the screen.

- This preview only appears if a channel was added by selecting "Yes."

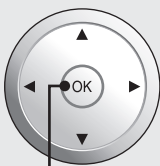
 Press to display the selected program.

6  RETURN

Press to move cursor to "Apply".

CH	Caption	Favorite	Add
1	No
2	ABC	2	Yes
3	No
4	No
5	No
6	No
7	No
8	No
9	No
10	No

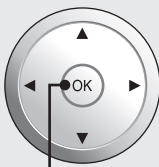
7  Press to enter your program.

Projection Display operation

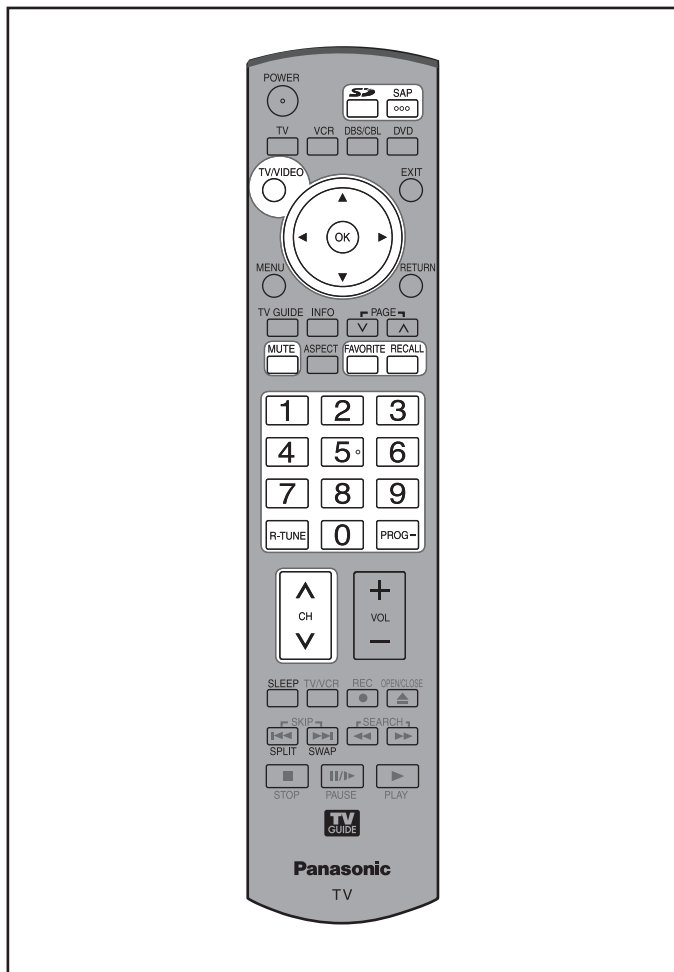

Input select	
[1]	TV
[2]	Component 1
[3]	Component 2
[4]	HDMI 1
[5]	HDMI 2
[6]	Video 1
[7]	Video 2
[8]	Video 3
[9]	PC

Component 1	Signal of source connected to COMPONENT VIDEO INPUT 1 is displayed.
Component 2	Signal of source connected to COMPONENT VIDEO INPUT 2 is displayed.
HDMI 1	Signal of source connected to HDMI IN 1 is displayed.
HDMI 2	Signal of source connected to HDMI IN 2 is displayed.
Video 1	Signal of source connected to INPUT 1 is displayed.
Video 2	Signal of source connected to INPUT 2 is displayed.
Video 3	Signal of source connected to INPUT 3 is displayed.
PC	Signal of source connected to PC IN is displayed.

Note:

- If SKIP is set as the Input Label setting, the mode will not be changed. (p. 65)

Selecting Input Mode

1  Press to display the Input select menu.

- Pressing TV/VIDEO while viewing PC input will place unit directly into TV input mode.

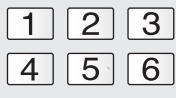
2  Press corresponding NUMBER keys on the Remote Control to select the input of your choice.

Or

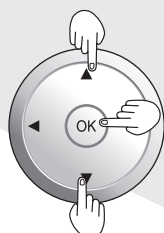
 Press to select the input of your choice, then press "OK".

- If, during selection, no action is taken for several seconds, the Input selection menu is exited and the current input is automatically selected.

■ Card input mode (Photo Viewer) is selected.



Press to display Photo Viewer mode.

Photo (Photo Viewer)	Signal of source connected to CARD SLOT is displayed.
-----------------------------	---

Rapid Tuning

Switches between the current and last channel or input modes.



Press to switch to previously viewed channel or input modes.

Note:

- When Photo Viewer (p. 54) or Split screen (p. 42) is used, Rapid Tuning is not available.

Projection Display operation (continued)

Using the CH/VOL Button

Select desired channel:

Press CH Δ or NUMBER keys.

Adjust to desired volume level:

Press VOL + or VOL -.

Notes:

- The channel number and volume level are stored even after the unit is turned off.
- Power consumption can be reduced if the volume level is lowered.

Channel and Program Tuning

Channel and Program tuning in digital television differs from conventional television. With DTV, many programs can exist within a single 6 MHz channel. These channels behave as sub-channels within a single channel. When tuning to a digital channel, the unit will also tune to a program and will indicate the channel and program in the on-screen Channel Banner display.

In order to select channels properly, Auto program must be performed. (p. 33)

Follow the procedure below to directly enter the channel number using the NUMBER keys on the Remote Control.

Select analog channel

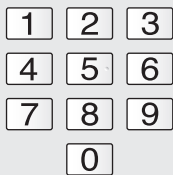
- 

Press the NUMBER keys on the Remote Control to enter the Channel number. Press OK. The following is an example of tuning to channel 15.



Direct Tuning Example

Step	Action	Channel Banner Display
1	Press 1	1
2	Press 5	15
3	Press OK	15

Note:

- If, during channel selection, no action is taken for several seconds, the Channel Banner is exited and the currently input channel is automatically selected.

Select digital channel

- 

If tuning a digital channel and your channel contains more than one program, press PROG and enter the program (1, 2, 3 etc.) using the NUMBER keys. Press OK. The following is an example of tuning to channel 15-1.
- 

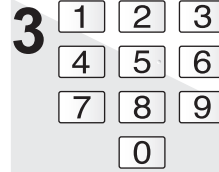

Direct Tuning Example

Step	Action	Channel Banner Display
1	Press 1	1
2	Press 5	15
3	Press -	15-
4	Press 1	15-1
5	Press OK	15-1



Note:

- If, during channel selection, no action is taken for several seconds, the Channel Banner is exited and the currently input channel is automatically selected.

Unit Status display

Press the Channel Δ or RECALL button, except when the MENU screen is displayed, to display current unit status information.

Channel Banner: Minimized



Press CH Δ to minimize the displayed channel banner. It will display the channel number, and the station identification (if available).

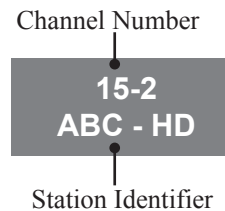

Note:

- The Station identifier is not displayed when you use Split Screen mode.

Channel Banner: Maximized



Press RECALL to maximize the displayed channel banner.

Channel, Program and Station identifier

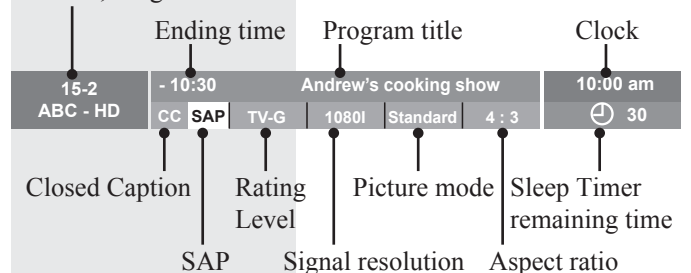

Audio Mute

Press MUTE to instantly mute the sound. Press again to restore the previous sound level.



Press this button to mute the sound. Press again to reactivate sound. Sound is also reactivated when power is turned off or volume level is changed.

Note:

- The audio output from AV OUT is not muted.

Favorite Feature

This feature lets you add channels to or delete channels from the Favorite channel list.

Set Favorite Feature

- 1 Display the channel to be placed on the Favorites list.

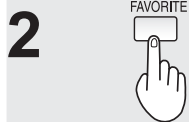

Hold down FAVORITE for several seconds.

- Press FAVORITE repeatedly to change between pages (1/3, 2/3, 3/3, or exit). Pressing ◀▶ also changes the page.

Setting 1/3	
[1]	
[2]	
[3]	
[4]	
[5]	
[6]	
[7]	
[8]	
[9]	
[0]	

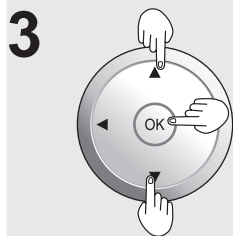

Press ▲▼ to highlight a position on the list.

Then, press OK to memorize the displayed CH in that position.

- You can also use the NUMBER keys (1-9 and 0) to select the recorded list numbers (1-9 and 0). By doing so, the numbers will be directly recorded without having to press the OK key.

Setting 1/3	
[1]	26-1
[2]	
[3]	
[4]	
[5]	
[6]	
[7]	
[8]	
[9]	
[0]	

■ To delete a favorite channel

A memorized channel can be removed from the list by holding down FAVORITE while its position is highlighted.

Use Favorite Feature

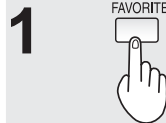

Press FAVORITE.

- Press FAVORITE repeatedly to change between pages (1/3, 2/3, 3/3, or exit). Pressing ◀▶ also changes the page.

Favorite 1/3	
[1]	
[2]	
[3]	
[4]	
[5]	
[6]	
[7]	
[8]	
[9]	
[0]	

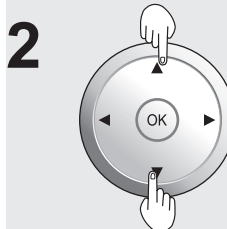

Press ▲▼ or a NUMBER keys (1-9 and 0) to highlight a channel on the list.

- Selecting a channel number from the list with the NUMBER keys will display the channel directly.

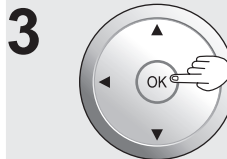

Press OK to display the highlighted channel.

Projection Display operation (continued)

Select Audio Mode for TV Viewing

Digital mode



Press SAP to select the next audio track (if available) when receiving a digital channel.

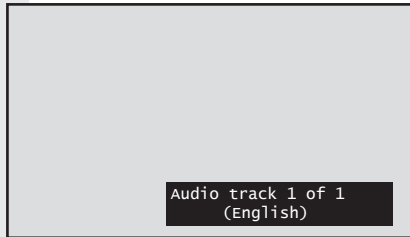

Analog mode



Press SAP button to select the desired audio mode as described below.
(Arrow shows selection.)

- Each press of SAP button will change the audio mode as shown below.
- "SAP" is selected with first press of SAP button.

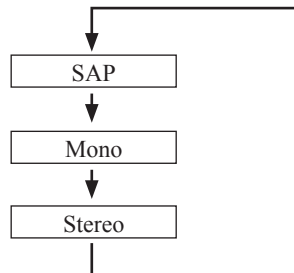
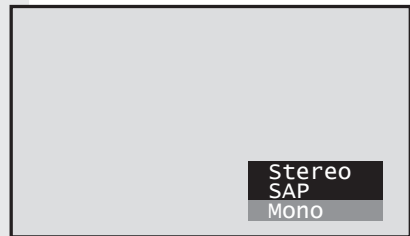

■ Receivable Broadcast Types

The following are possible broadcast types with their accompanying on-screen displays. The signal being received is indicated with a red text while the selected audio mode is yellow background.

MTS Stereo and SAP broadcast

Multi-channel Television Sound Stereo (main language) and Secondary Audio Program (sub language) broadcasts are both being received simultaneously. Select the Stereo or SAP audio mode.

MTS Stereo broadcast

Multi-channel Television Sound Stereo broadcast. Select Stereo audio mode.

- If stereo broadcast is weak and the display flickers, select Mono audio mode for possibly better results.

SAP broadcast

Secondary Audio Program (sub language.) Select SAP audio mode for the sub language.

Mono broadcast

Normal monaural sound broadcast.

Sleep Timer Feature

Switches the unit OFF in a preset amount of time from 0 to 90 minutes in 30 minute intervals.



Press SLEEP repeatedly to select the desired time.

- To cancel, press SLEEP repeatedly until 0 appears. Also, turning Power OFF while setting SLEEP will reset to zero.

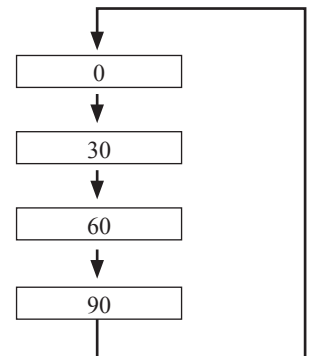

Notes:

- Pressing RECALL with sleep timer set displays remaining time. This can also be done by pressing SLEEP. If you continue to press SLEEP, the sleep time setting mode will be entered.
- Sleep time may also be set from the Menu screen. (p. 49)
- The on-screen display will flash 3, 2 and 1 to indicate the last three (3) remaining minutes prior to turn off.

ASPECT Controls

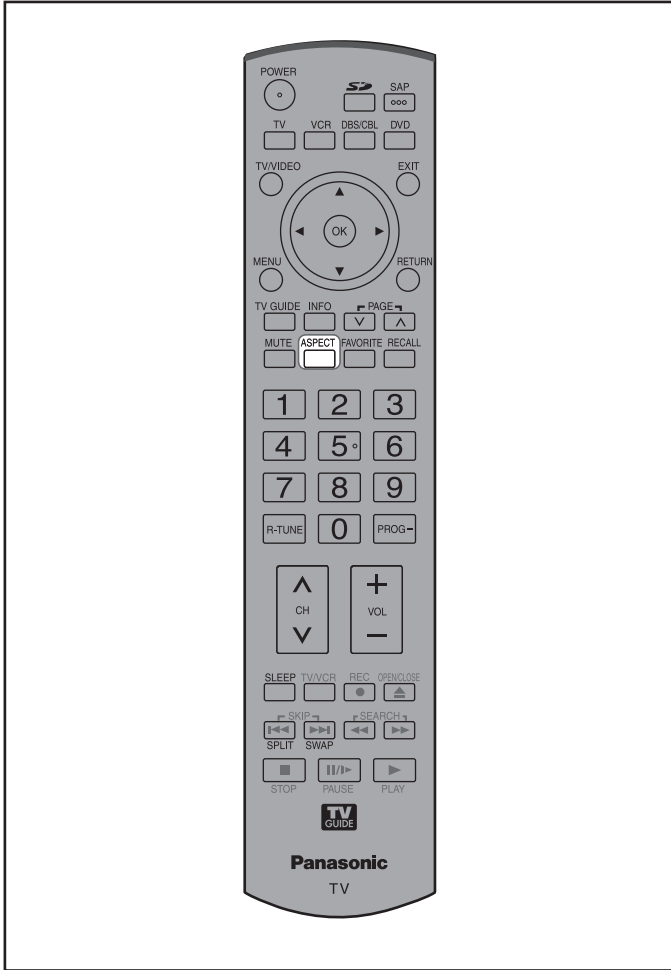

Notes:

- When a 1080p (HDMI) signal is received, the aspect is set to FULL and cannot be changed.
- When input mode is CARD, the aspect is set to 4:3 and cannot be changed.
- If the mode selected does not match the aspect ratio of the input signal, the original picture quality may be affected.
- If using this Projection Display in places, such as cafes or hotels, with the aim of displaying programs for a commercial purpose or for public presentation, please note that by using the aspect ratio (16:9) selection function to change the aspect ratio, you may be infringing on the rights of the original copyright owner of that program under copyright protection laws.
- If a 4:3 picture is projected in wide screen, distortion may occur around the edges so that part of the picture may no longer be visible. We recommend viewing in 4:3 mode so you can enjoy the picture as it was intended to be seen.

Mode	Picture	Explanation
JUST		JUST mode will display a 4:3 picture at maximum size, but with aspect correction applied to the center of the screen so that elongation is only apparent at the left and right edges of the screen. The size of the picture will depend on the original signal.
4:3		4:3 mode displays a 4:3 picture at the standard 4:3 size.
ZOOM		ZOOM mode magnifies the central section of the picture.
FULL		FULL mode displays the picture at maximum size, but with a slightly elongated appearance.
H-FILL		H-FILL mode enlarges a 4:3 image horizontally to the sides of the screen. The side edges of the image are cut off.

Changing the Aspect Mode

Lets you choose the aspect mode based on the format of the received signal and your preference.



The aspect mode changes each time ASPECT is pressed.

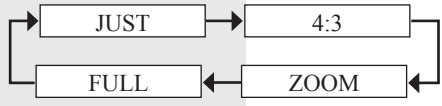

- When an HD signal (1080i/720p) is received, the mode switches between FULL, H-FILL, JUST, and ZOOM.

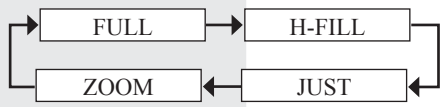

- During PC input, the mode switches between 4:3 and FULL only.

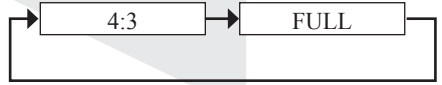

Split screen

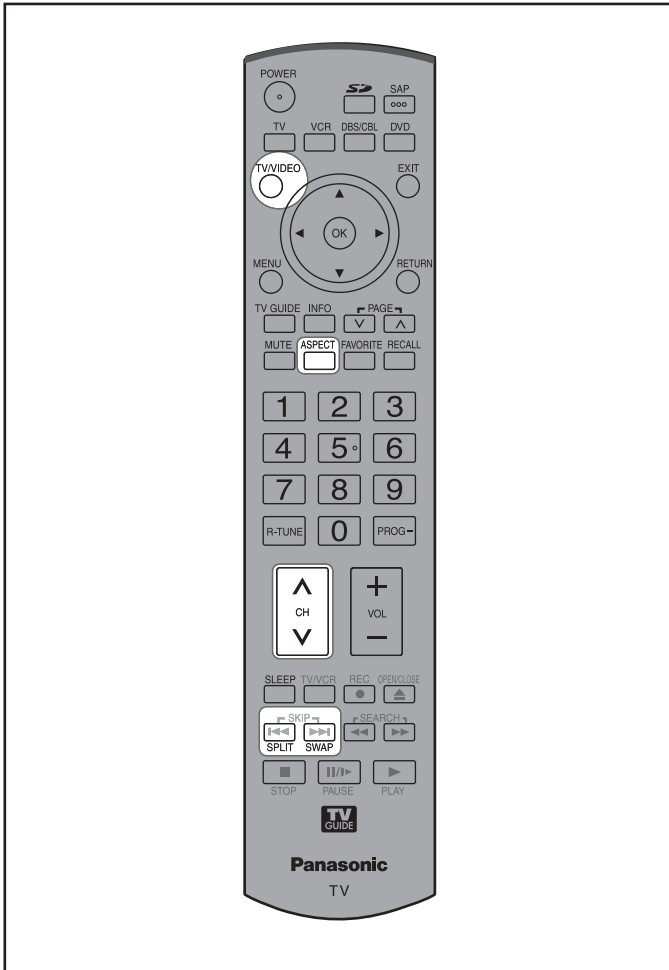

■ Returning to one screen (Left screen)



Notes:

- Sound from the Left screen is output from the speakers on the Projection Display set.
- When the screen is split, signal of the Left screen is output from the rear monitor output terminal. (p. 17)
- The left and right screens are processed by individual circuits and, therefore, may vary in image quality.
- Split screen returns to single screen when the unit is turned off.
- The right and left screens essentially cannot display the same picture at the same time.
- Photo Viewer, PC, HDMI 1, and HDMI 2 cannot be displayed using the Split screen function.
- The aspect mode cannot be changed using the Split screen function.

Splitting the screen

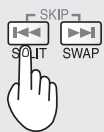

Press to split.
(The previously selected screen appears on the left.)

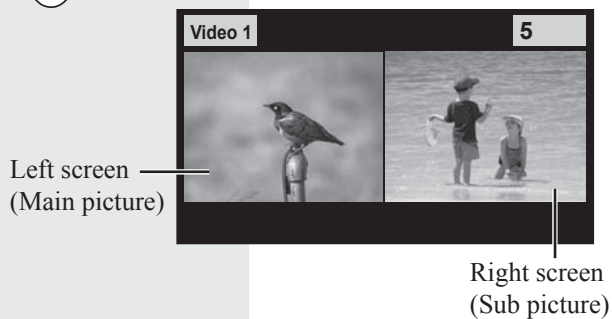

Changing the channel

The channel on the TV display side of the screen can be changed.

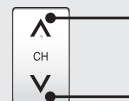

Press to select the desired channel.

Example:
During SPLIT SCREEN NORMAL

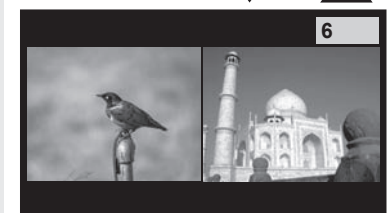

Select desired input mode of the Right screen



Press to select the desired input mode.

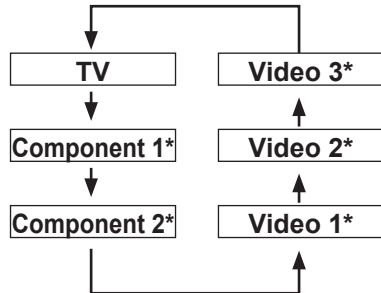

* If SKIP is set as the Input Label setting, the mode will not be changed. (p. 65)

Changing the Viewing Condition



Press to change the viewing mode.

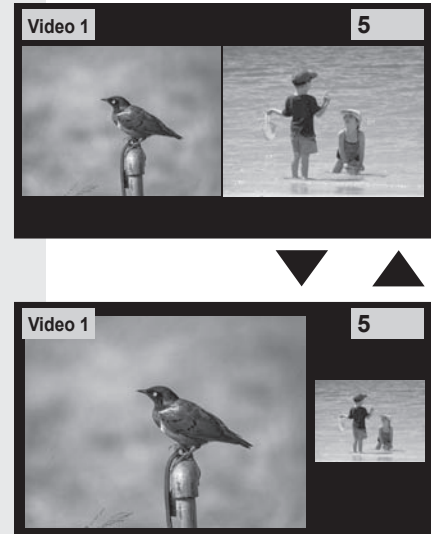

Swapping left and right screens

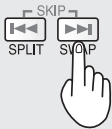

Press to swap.

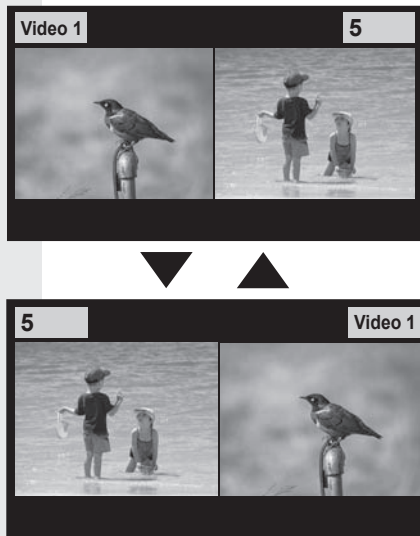

Note:

- Picture quality may change according to the combination of signals input to the left and right screens.

Picture Adjustments

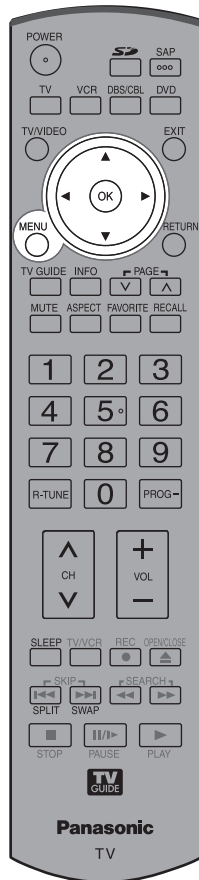

Normal / Picture / Brightness / Color / Tint / Sharpness / Color temp



Press to select each item.

Press to adjust each item.

* When a 1080p (HDMI) signal is received:

Picture	
Normal	Set
Pic. mode	Standard
Picture	+20
Brightness	0
Color	0
Tint	0
Sharpness	0
Color temp	Normal

Picture 1/2	
Normal	No
Pic. mode	vivid
Picture	+10
Brightness	+10
Color	+10
Tint	+10
Sharpness	+10



Picture 2/2	
Color temp	Normal
Color mng.	On
Zoom adjust	
PC adjust	
Other adjust	
Adv. adjust	

Press MENU to display the Main Menu screen.

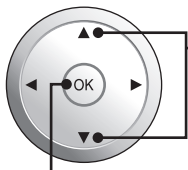

Press to select "Picture" icon.

Press to display the Picture menu.

Menu	
<input type="checkbox"/>	Picture
<input type="checkbox"/>	Audio
<input type="checkbox"/>	Timer
<input type="checkbox"/>	Lock
<input type="checkbox"/>	TVG / Photo
<input type="checkbox"/>	Setup

(PC input menu)

Menu	
<input type="checkbox"/>	Picture
<input type="checkbox"/>	Audio

- Picture Menu is inaccessible when no signal is present.
- * When a 1080p (HDMI) signal is received, the Main Menu screen cannot be displayed. However, the Picture Menu screen (Normal, Pic. mode, Picture, Brightness, Color, Tint, Sharpness, and Color temp) can be displayed. (p. 23)

Item	Explanations
Normal	Resets all picture adjustments to factory default settings.
Picture	Adjusts white areas of picture.
Brightness	Adjusts dark areas of picture.
Color	Adjusts to desired color intensity.
Tint	Adjusts for natural flesh tones.
Sharpness	Adjusts clarity of outline detail.
Color temp (Color temperature)	Increases or decreases Warm (red) and Cool (blue) colors as desired.
Color mng. (Color management)	Enhances green and blue color reproduction, especially for outdoor scenes. When a 1080p (HDMI) signal is received, this feature is "off".

Depending on the signal being input, some menu items may or may not be adjustable and some functions may or may not be available.

Picture Mode

Lets you choose one of three pre-set Picture Modes that best suits the program to which you are viewing. Selecting this feature will also affect Color Temperature setting.

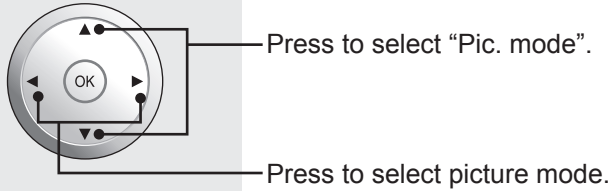

Picture 1/2	
Normal	No
Pic. mode	Vivid
Picture	+10
Brightness	+10
Color	+10
Tint	+10
Sharpness	+10

- Vivid - This is the default mode, It provides enhanced picture contrast and sharpness for viewing in a well-lit room.
- Standard - Recommended for normal viewing conditions with subdued room lighting.
- Cinema - Select this mode for watching movies in a darkened room. It provides a soft, film-like picture.

Zoom Adjust

Adjust the Zoom position. It works when Aspect mode is Zoom.

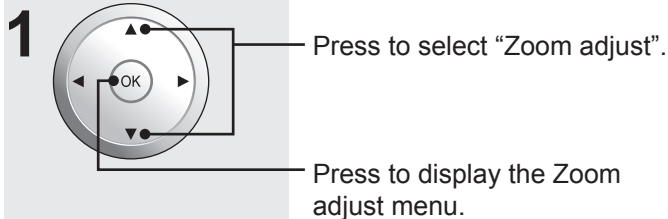

Picture 2/2	
Color temp	Normal
Color mng.	On
Zoom adjust	
PC adjust	
Other adjust	
Adv. adjust	

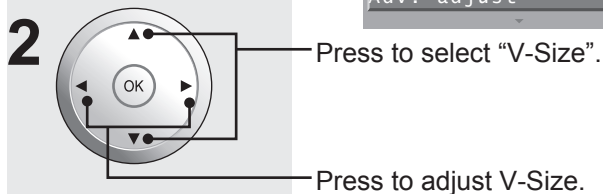

Zoom adjust	
V-Size	10

- V-Size - Adjust the vertical size.

PC Adjust

You can adjust the picture when viewing a signal from a PC.

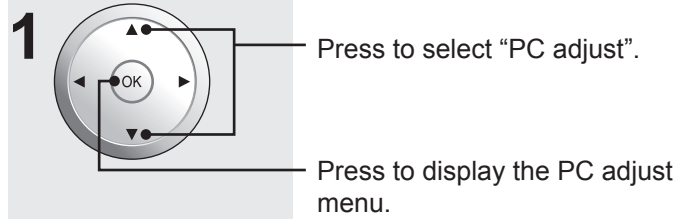

Picture 2/2	
Color temp	Normal
Color mng.	On
Zoom adjust	
PC adjust	
Other adjust	
Adv. adjust	

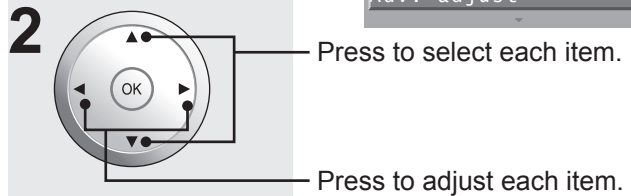

PC adjust 1/2	
Normal	No
Dot clock	+10
H-Position	+10
V-Position	+10

PC adjust 2/2	
Clock phase	+10
Resolution	XGA
H-Frequency	48.4kHz
V-Frequency	60.1Hz

Item	Explanations
Normal	Resets all picture adjustments to factory default settings.
Dot clock	Adjusts horizontal size.
H-Position	Adjusts horizontal position.
V-Position	Adjusts vertical position
Clock phase	Adjust in order to remove any picture interference or contour blurring which may occur in computer images.
Resolution	Switches to wide display. Input signal switched from XGA to WXGA.
H-Frequency/ V-Frequency	Displays the frequencies of the PC signal currently being adjusted. Displays the H (Horizontal) / V (Vertical) frequencies. Display range: Horizontal 15 - 110 kHz Vertical 48 - 120 Hz

Note:

- This function is available only when the signal being viewed is from a PC.

Picture Adjustments (continued)

Other Adjust

Other detailed picture adjustments can be made.

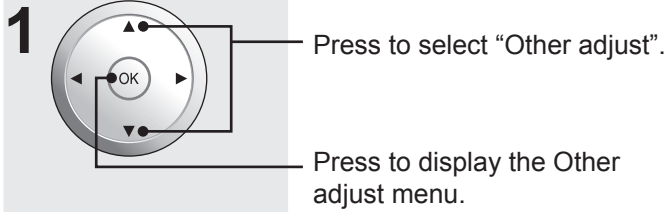

Picture 2/2	↩
Color temp	Normal
Color mng.	On
Zoom adjust	
PC adjust	
Other adjust	
Adv. adjust	

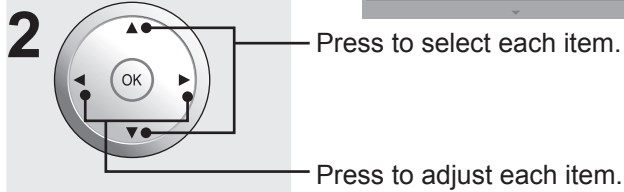

Other adjust	↩
Video NR	On
3D Y/C filter	On
Color matrix	SD
MPEG NR	On
Black level	Light
3D I/P	On
Color corr.	On

Item	Explanations
Video NR	Reduces noise, commonly called snow. Leave off when receiving a strong signal.
3D Y/C filter	Minimizes noise and cross-color in the picture.
Color matrix	Select SD or HD. <ul style="list-style-type: none"> • SD : Color matrix is set same as a normal TV system (NTSC). • HD : Color matrix is set same as a High-Definition system (ATSC). With a 480p signal from equipment connected to COMPONENT VIDEO INPUT (Y, PB, PR) or HDMI INPUT terminals or from the unit's DTV tuner, you can select SD or HD color matrix to display the most natural color. Notes: <ul style="list-style-type: none"> • This feature is available only with 480p signals. • The default setting with HDTV signals (720p or 1080i) is HD color matrix. • The default setting with NTSC signals (480i) is SD color matrix.
MPEG NR	Unique noise to DVD, STB, etc. will be reduced.
Black level	Select Light or Dark [Dark : Analog channel/VIDEO, Light : 480i/480p/720p/1080i] Invalid for Digital channel, PC and Photo Viewer.

Item	Explanations
3D I/P	Film media (taken at 24 frames per second) is faithfully reproduced on the unit. On: Recordings created at 24 frames per second are shown in higher quality. Off: Set to Off if picture appears unnatural.
Color corr.	With HDMI connection, depending on the signal, the picture may be displayed with unnatural colors (as if red and blue are reversed). Correct by setting the Color corr. to "On."

Advanced Adjust

Highly-detailed adjustments can be made.

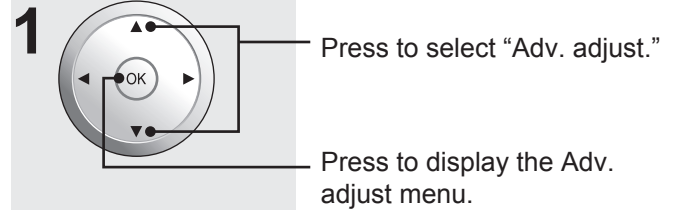

Picture 2/2	↩
Color temp	Normal
Color mng.	On
Zoom adjust	
PC adjust	
Other adjust	
Adv. adjust	

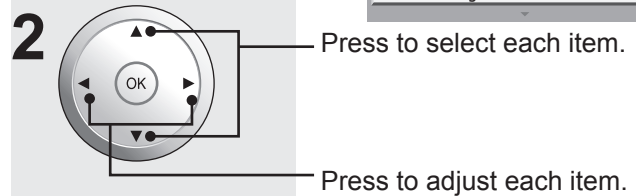

Adv. adjust	↩
Normal	No
Dynamic iris	On
Gamma adj.	Full
Blk. extension	+10
R level	+10
G level	+10
B level	+10

Item	Explanations
Normal	Resets all picture adjustments to factory default settings.
Dynamic iris	The amount of light is controlled to project the images with high contrast. When a 1080p (HDMI) signal is received, this feature is "off".
Gamma adj.	The median brightness level of the picture can be set.
Blk. extension	You can adjust the gray level of black for areas of the screen that are darker than the median level.
R level	Adjusts the red component.
G level	Adjusts the green component.
B level	Adjusts the blue component.

Audio Adjustments



Normal / Bass / Treble / Balance



Press to select each item.

Press to adjust each item.

Audio	↩
Normal	No
Audio mode	Standard
Bass	+10
Treble	+10
Balance	+10
BBE	Off
Other adjust	

Item	Explanations
Normal	Reset Bass, Treble and Balance adjustments to factory default settings.
Bass	Increase or decrease the bass response.
Treble	Increase or decrease the treble response.
Balance	Emphasize the left / right speaker volume.

Press MENU to display the Main Menu screen.

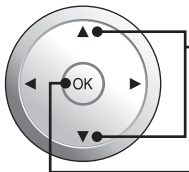

Press to select "Audio" icon.

Press to display the Audio menu.

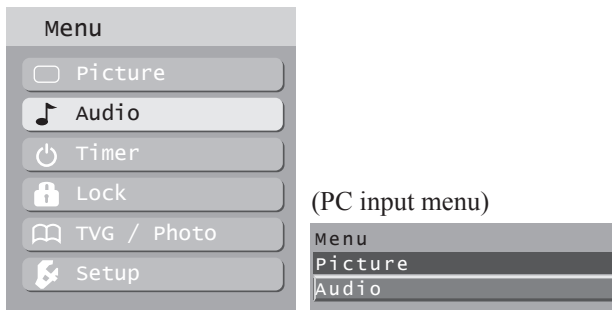

- If the unit is set to AI sound "On," BBE "On," or "VIVA 3D," only the Balance item can be adjusted in the Audio menu.
- When a 1080p (HDMI) signal is received, the Main Menu screen cannot be displayed. (p. 23, 44)

Audio Mode

Lets you choose one of three pre-set Audio Modes that best suits the program to which you are listening.



Press to select "Audio mode".

Press to select audio mode.

Audio	↩
Normal	No
Audio mode	Standard
Bass	+10
Treble	+10
Balance	+10
BBE	Off
Other adjust	

- Standard Emits the original sound.
- Dynamic Sound suited to music or movie.
- Speech Sound suited to dialogue.

Depending on the signal being input, some menu items may or may not be adjustable and some functions may or may not be available.

BBE

You can hear a deeper, 3-D sound effect using just the unit's two front speakers.



Press to select "BBE".

Press to select BBE setting.

Audio	
Normal	No
Audio mode	Standard
Bass	+10
Treble	+10
Balance	+10
BBE	Off
Other adjust	

- VIVA 3D BBE ViVA HD 3D - BBE ViVA HD 3D (High Definition 3D) Sound provides musically accurate natural 3D image with Hi-Fi sound. The clarity of the sound is improved by BBE while the width, depth and height of sound image are expanded by BBE's proprietary 3D sound process. BBE ViVA HD3D Sound is compatible with all TV programs including news, music, dramas, movies, sports and electronic games.
- On BBE - BBE High Definition Sound is a proprietary audio enhancement technology that compensates for phase and amplitude distortion inherent in the nature of loudspeaker physics. BBE works like an automatic focus in a camera, bringing incredible clarity, depth and detail to the sound.
- Off Sound is normal.

Other Adjust

Other detailed audio adjustments can be made.

1

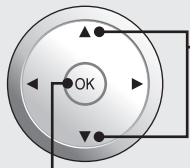

Press to select "Other adjust".

Press to display the Other adjust menu.

Audio	
Normal	No
Audio Mode	Standard
Bass	+10
Treble	+10
Balance	+10
BBE	Off
Other Adjust	

2



Press to select each item.

Press to adjust each item.

Other adjust	
AI sound	On
Speakers	On
HDMI1 in	Auto
HDMI2 in	Auto
Audio leveler	+7

Item	Explanations
AI sound	Equalize overall volume levels across all channels. (AI sound is not available in VIDEO mode).
Speakers	This feature is used to turn TV speakers On or Off. <ul style="list-style-type: none"> • On - TV speakers operate normally. • Off - TV speakers off.
HDMI1 in/ HDMI2 in	Perform input switching of analog audio input and digital audio input when using the HDMI terminal. Auto : Automatically performs digital/analog input switching according to the input signal type. Digital : Forces use of digital audio input signal transmitted via the HDMI terminal. Analog : Forces use of analog audio input signal transmitted via separate RCA terminals.
Audio leveler	The audio leveler monitors the difference in audio levels between input signals from external equipment and minimizes the change in output volume that could occur when switching input signals. <ul style="list-style-type: none"> • "Audio leveler" is not available when "Speakers" is set to "Off".

Notes:

- Sound signals are output from the rear AUDIO OUT and DIGITAL AUDIO OUT terminal. (p. 18-19)
- When volume is adjusted or the MUTE button is pressed from the Remote Control, a message will be displayed.

Sleep Timer Feature



Set Sleep Timer

Press to set unit to shut itself off after a preselected amount of time.



Press to select "0," "30," "60," or "90".



Notes:

- Pressing the RECALL button with sleep timer set displays remaining time.
- The on-screen display will flash 3, 2 and 1 to indicate the last three (3) remaining minutes prior to turn off.

Press MENU to display the Main Menu screen.

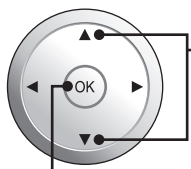

Press to select "Timer" icon.

Press to display Timer menu.

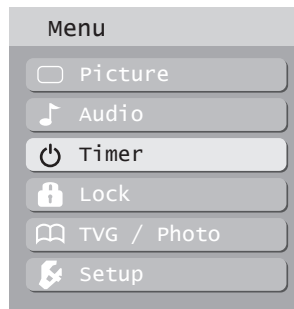

- Sleep time may be set using the SLEEP button. (p. 40)
- When a 1080p (HDMI) signal is received, the Main Menu screen cannot be displayed. (p. 23, 44)

Lock Feature

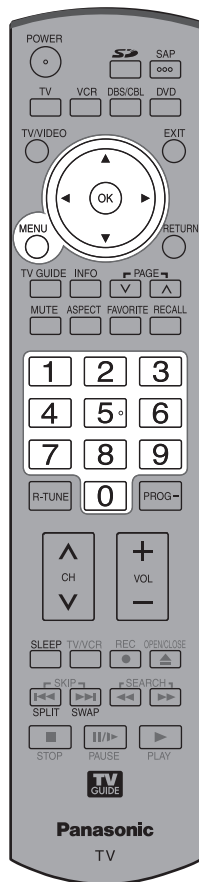

Press MENU to display the Main Menu screen.

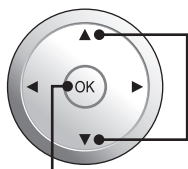

Press to display the options in the Lock menu.

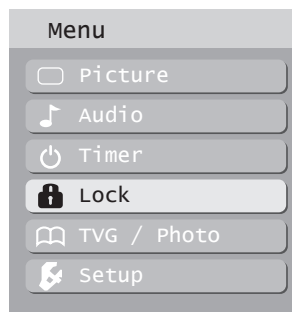

- You will be asked to enter your password each time you display the Lock menu.
- When a 1080p (HDMI) signal is received, the Main Menu screen cannot be displayed. (p. 23, 44)

This Projection Display incorporates V-CHIP technology to block the viewing of movies and television programs according to the rating category. There are four (4) Content Advisory Categories: MPA (Motion Picture Association of America), TV Parental Guidelines Ratings, Canadian English Language Ratings and Canadian French Language Ratings. These categories are used as guidelines for blocking the programs. The default mode for the Lock category is the Unlocked state. In this state, you can surf the various categories of the Lock menu. After you have created a password, you are prompted to enter it before you can make any changes in the Lock menu.

Enter Secret Code

A 4-digit code must be entered to view a blocked program or change rating settings.

■ Create Secret Code (First Time Setting)



Press NUMBER keys to enter your secret code.

Note:

- Use a code that is easy to remember and record it in a safe place.

Create password.

Enter new password, again

Password was set.

Upon entering the 4 digit code, the Lock menu is displayed.

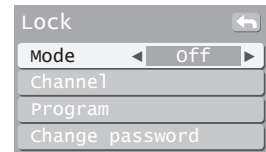

■ Enter Secret Code



Press NUMBER keys to enter your secret code.

Enter password.

Upon entering the 4 digit code, the Lock menu is displayed.

Notes:

- Once ratings are set, restricted tapes or programs cannot be accessed unless the secret code is entered.
- **Do not forget your password.** If you have forgotten it, please contact a service center.

Lock Set

Select Lock mode to prevent viewing of video games, VCR tapes, channels and Video modes.

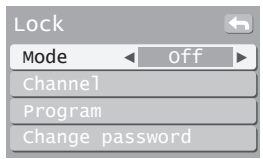
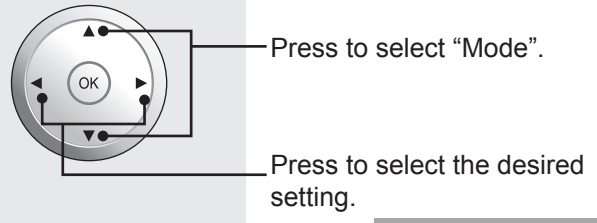

To prevent video games, VCR tapes and all channels and video modes from being viewed. The available modes are:

- Off - Turns off Lock set functions.
- All - All channels are locked regardless of the rating level.
- Game - Locks out CH 3, 4 and Video inputs.
- CH - Locks out specific analog and digital channels. Password is required to view any of the locked channels.

Channel Lock (Block channel selection)

Select up to 7 (1-7) channels to be blocked out. These channels will be blocked out regardless of the program rating.

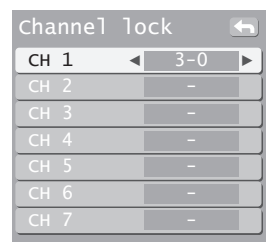
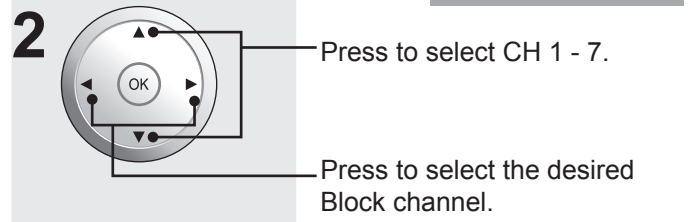
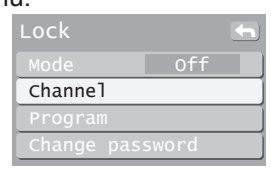
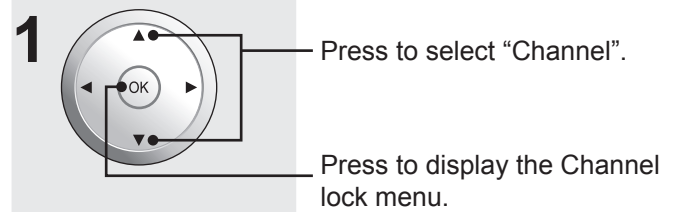

Block program

This television incorporates V-Chip technology to block the viewing of movies and television programs according to the rating category. There are four (4) Content Advisory Categories: MPAA (Motion Picture Association of America), U.S.TV Program, Canadian English ratings and Canadian French ratings. These categories are used as guidelines for blocking programs.

- The default mode for the Lock category is the Unlocked state.

Rating level setting

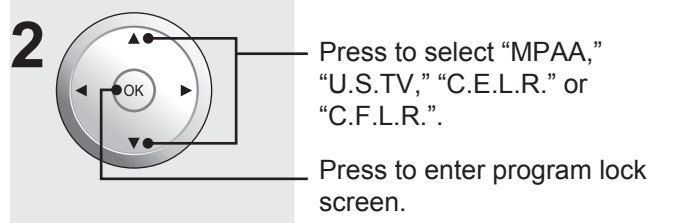
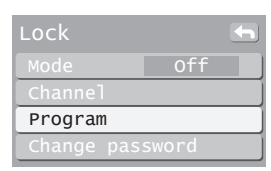
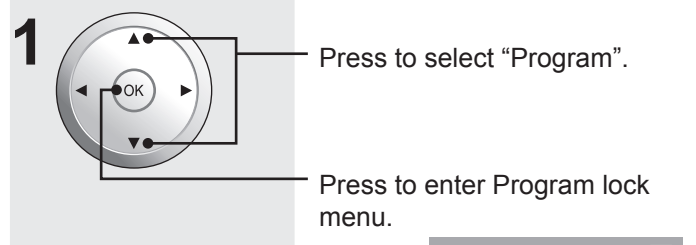

MPAA : for U.S movie ratings
 U.S.TV : for U.S TV program ratings
 C.E.L.R. : for Canadian English ratings
 C.F.L.R. : for Canadian French ratings

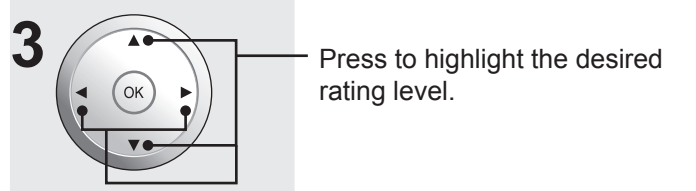
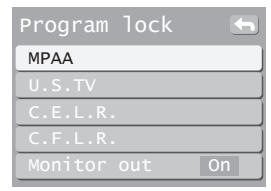

Lock Feature (continued)

Monitor out setting

1

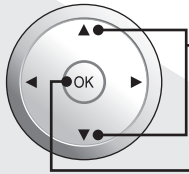

Press to select "Program".

Press to enter program lock menu.

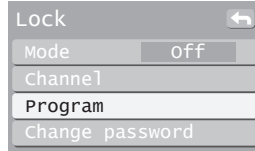

2

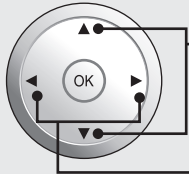

Press to select "Monitor out".

Press to select "On" or "Off".

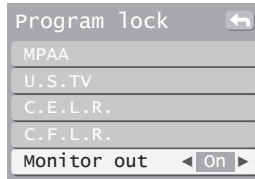

On: Turns on the monitor terminal output for programs that have been set to "Blocked."

Off: Turns off the monitor terminal output for programs that have been set to "Blocked."

Notes:

- The Off rating is independent of other ratings.
- When placing a block on a specific age based rating level, the Off rating and any other more restrictive ratings will also be blocked.

U.S. MOVIES RATINGS CHART (MPAA)

Off	NO RATING (NOT RATED) AND NA (NOT APPLICABLE) PROGRAMS. Movie has not been rated or rating does not apply.
G	GENERAL AUDIENCES. All ages admitted.
PG	PARENTAL GUIDANCE SUGGESTED. Some material may not be suitable for children.
PG-13	PARENTS STRONGLY CAUTIONED. Some material may be inappropriate for children under 13.
R	RESTRICTED. Under 17 requires accompanying parent or adult guardian.
NC-17	NO ONE 17 AND UNDER ADMITTED.
X	ADULTS ONLY.

U.S. TV PROGRAMS RATINGS CHART

The TV Parental Guidelines has 7 levels of age-based ratings that can be selected. These 7 levels are split into 2 age-based groups:

Youth Age-based Ratings and Guidance Age-based Ratings. Some of these age-based ratings can also have content-based ratings, denoted as D (Dialog), L (Language), S (Sex) and V (Violence). The table below shows the age-based ratings selection.

Age-based Group	Age-based Ratings	Blocked Content Selections	Description
NR (Not Rated)	TV-NR	• Viewable • Blocked	Not Rated. See "Customer Caution" on page 53.
Youth	TV-Y	• Viewable • Blocked	All children. The themes and elements in this program are specifically designed for a very young audience, including children from ages 2-6.
	TV-Y7	• FV (Fantasy Violence) • Viewable • Blocked	Directed to older children. Themes and elements in this program may include mild physical or comedic violence, or may frighten children under the age of 7.
Guidance	TV-G	• Viewable • Blocked	General audience. It contains little or no violence, no strong language, and little or no sexual dialogue or situations.
	TV-PG	• D,L,S,V (all selected) • Any combination of D, L, S, V	Parental guidance suggested. The program may contain infrequent coarse language, limited violence, some suggestive sexual dialogue and situations.
	TV-14	• D,L,S,V (all selected) • Any combination of D, L, S, V	Parents strongly cautioned. This program may contain sophisticated themes, sexual content, strong language and more intense violence.
	TV-MA	• L,S,V (all selected) • Any combination of L, S, V	Mature audiences only. This program may contain mature themes, profane language, graphic violence, and explicit sexual content.

FV : Fantasy/Cartoon Violence.

V : Violence

S : Sex

L : Offensive Language

D : Dialogue with sexual content.

CANADIAN ENGLISH RATINGS CHART

E	Exempt - Exempt programming includes: news, sports, documentaries and other information programming, talk shows, music videos, and variety programming.
C	Programming intended for children under age 8. No offensive language, nudity or sexual content.
C8+	Programming generally considered acceptable for children 8 years and over. No profanity, nudity or sexual content.
G	General programming, suitable for all audiences.
PG	Parental Guidance suggested. Some material may not be suitable for children.
14+	Programming contains themes or content which may not be suitable for viewers under the age of 14. Parents are strongly cautioned to exercise discretion in permitting viewing by pre-teens and early teens.
18+	18+ years old. Programming restricted to adults. Contains constant violence or scenes of extreme violence.

CANADIAN FRENCH RATINGS CHART

E	Exempt - Exempt programming.
G	General - Programming intended for audience of all ages. Contains no violence, or the violence content is minimal or is depicted appropriately.
8 ans +	8+ General - Not recommended for young children. Programming intended for a broad audience but contains light or occasional violence. Adult supervision recommended.
13 ans +	Programming may not be suitable for children under the age of 13 - Contains either a few violent scenes or one or more sufficiently violent scenes to affect them. Adult supervision strongly suggested.
16 ans +	Programming may not be suitable for children under the age of 16 - Contains frequent scenes of violence or intense violence.
18 ans +	Programming restricted to adults. Contains constant violence or scenes of extreme violence.

Customer Caution

The V-Chip system that is used in this set is capable of blocking "NR" programs (non rated, not applicable and none) as per FCC Rules Section 15.120(e)(2). If the option of blocking "NR" programs is chosen "unexpected and possibly confusing results may occur, and you may not receive emergency bulletins or any of the following types of programming:"

- Emergency Bulletins (Such as EAS messages, weather warnings and others)
- Locally originated programming • News • Political • Public Service Announcements • Religious • Sports
- Weather

Blocking Messages

Various Blocking messages are displayed on-screen depending upon the type of blocking you have selected in the Lock menu.

Notes:

- Entering the password will override the block condition. However, the ratings selection will be retained.
- Block cannot be canceled during Split Screen mode. Return to a single screen to cancel.

Message	Possible cause
Game locked.	The TV/VIDEO button was pressed when the Game lock had been selected.
Channel Locked.	Tuned to the designated channel when the Channel lock had been selected.
All locked.	Tuned to CH 3 or CH 4 when the Game lock had been selected. Lock all is selected.
Program locked.	Received program that exceeds the Block Program rating level.

Change password

1

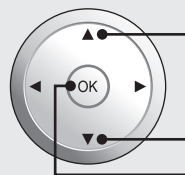

Press to select "Change password".

Press to enter the Input Password screen.

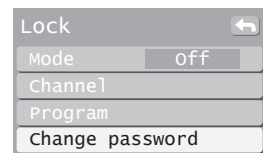

2

Change a 4-digit password to enter the Lock menu.

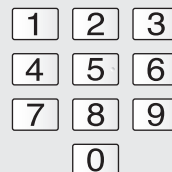

Enter a 4-digit password.



After entering your password for the first time, "Enter new password" will change to "Enter password".

Notes:

- Use a code that is easy to remember and record it in a safe place.
- **Do not forget your password.** If you have forgotten it, please contact a service center.

Photo Viewer

Still image data (JPEG) made with a digital camera or digital video camera can be played back using an SD Card.

⚠ WARNING

As with any small object, SD cards can be swallowed by young children. Do not allow children to handle the SD card.

⚠ CAUTION

1. Always insert card in the correct direction. Failure to do so may result in damage to the card and this unit.
2. The SD Card is precision devices. Do not subject them to excessive pressure or strong impacts.

Card Data Protection

- Do not remove the card while it is being accessed.
- Do not touch the terminals on the back of the SD Card.
- Electrical interference, electrostatic discharges and malfunctions of the unit or card may all result in damage to the card or data loss. It is recommended that any important data is also backed up on a PC.
- Stored data should be periodically backed up as a protection against data corruption, data loss or device malfunction. Please note that our company shall not accept any liability for damage or loss of stored data.

Data Format for Card Browsing

Photo:	Still images recorded with digital still cameras compatible with JPEG files of DCF* and EXIF standards
Data format:	Baseline JPEG 160 × 120 - 2 560 × 1 920 pixels (Sub-sampling: 4:4:4, 4:4:2 or 4:2:0)
Max. number of files:	9 999
Image resolution:	8 × 8 to 5 120 × 3 840

* DCF (Design rule for camera file system): A Japan Electronics and Information Technology Industries Association's standard

Notes:

- Some parts of an image may not be displayed or the image may be displayed on a smaller scale depending on the size of the image.
- Only JPEG images can be displayed on this unit.

Insert/Remove the Card

⚠ CAUTION

Do not remove the SD card while "Accessing" is being displayed on screen. Otherwise data may be lost or corrupted.

Insert the Card

With the SD logo facing upward, insert the Card horizontally into the SD Card Slot. The card is secured when you hear a click.

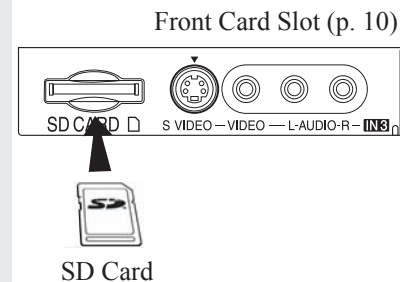

Remove the Card

Gently press in on the Card and release slowly. Pull the Card from the slot.

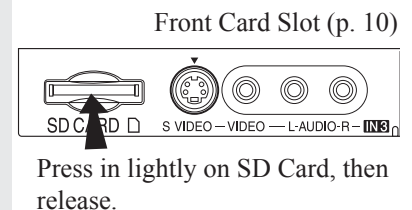

Notes:

- Compliant card type (maximum capacity): SD Card (2 GB), Mini SD Card (1 GB) (requiring mini SD adaptor).
- Remove the Card carefully to prevent it from popping out of the slot too fast.

JPEG thumbnail

The screen below is displayed automatically while a card is inserted. If “Is memory card in?” appears, check if a card is inserted. If not, turn the unit power off, correctly insert a card, then turn the unit back on. Now, place unit into Photo Viewer mode.

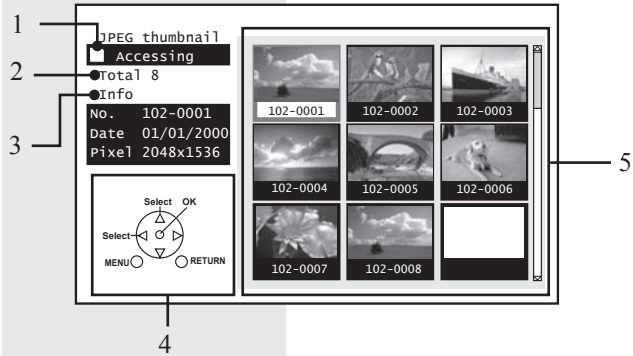

1	ACCESS Indication	“Accessing” is displayed while data is read. Note: • Proceed with all operations after “Accessing” has disappeared from the screen.
2	Total	Total number of JPEG images on the inserted card is displayed.
3	Info	Selected picture information is displayed. No. : Image number or file name is displayed. Date : Date of recording is displayed. Pixel : Display resolution is displayed. Note: • Depending on the JPEG type, Info contents may not be displayed correctly.
4	Navigation Area	Operational buttons are displayed as “GUI” (Graphical User Interface).
5	Index Area	JPEG images contained on the inserted card are displayed for viewing. Notes: • Only JPEG files can be displayed. • Up to 9 999 JPEG files can be displayed. • If images have duplicate numbers, none of the images will be displayed. • Depending on the JPEG type, it may not be displayed normally.

Card Warning Messages

If there is a problem with the card or card data, the following messages will appear.

Message	Description
Is memory card in?	A card may not be inserted, or the card format may not be supported. (Use SD cards formatted in a digital camera.)
No file.	The card may not contain image data, or all images on the card may be incompatible.



Press MENU to display the Main Menu screen.

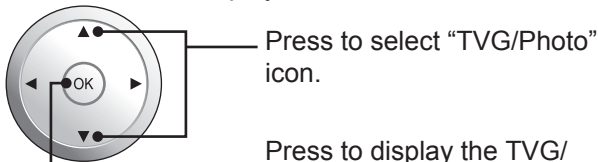

Press to display the TVG/ Photo menu.

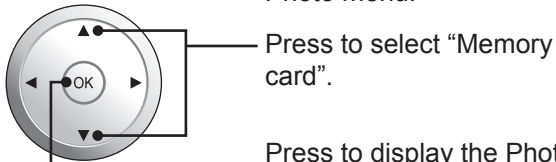

Press to display the Photo Viewer.

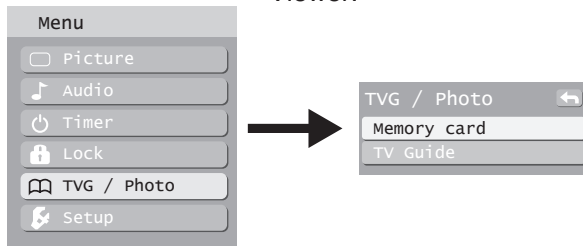

- The SD button may also be pressed for Photo Viewer mode. (p. 37)
- When a 1080p (HDMI) signal is received, the Main Menu screen cannot be displayed. (p. 23, 44)

Photo Viewer (continued)

Index Area Operation

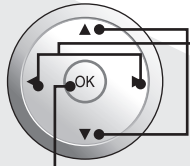

Press to select file.

Press to display full size file preview. (p. 57)

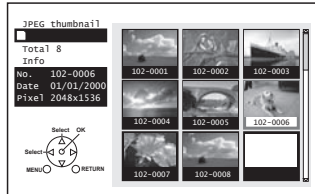

Notes:

File names will not be displayed correctly if...

- More than 8 characters are used.
- Spaces and special symbols are used. Use care when changing file names.

Exit Photo Viewer

Pressing SD while a JPEG thumbnail is displayed redisplay the last viewed input.

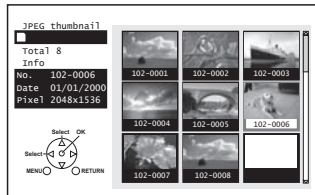

Press SD to exit Photo Viewer.

Slide Show Mode

Press ▲▼◀▶ to move cursor to desired file in INDEX AREA.

Press OK to display file in full screen size.

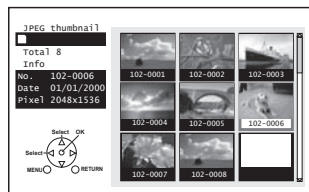

1 Press to display the Single setting menu.

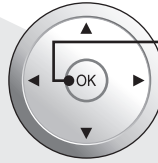

2 Press to select each item.

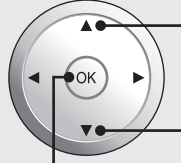

Press to set each item.

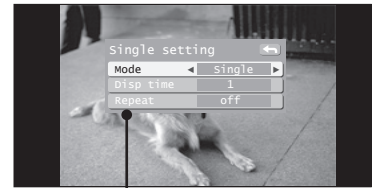

Single setting menu

Mode	Set to Single/Slide to view single images or perform a slide show.
Disp time	You can set how many seconds each image is displayed in Slide mode.
Repeat	Turn the slide show Repeat function On or Off.

3 Press to start slide show.



Example:

If Display Mode is set to Slide, Disp time is set to 5 seconds, and Repeat is Off.



Displayed
5 seconds



Displayed
5 seconds



Stop

4 Press OK during a slide show to stop it. The sub-menu is displayed.

Navigation Display

Pressing RECALL during Slide Show mode allows you to display or remove the Navigation Area.



Navigation Area

Exit Slide Show mode

Pressing RETURN during Slide Show mode allows you to exit the mode.



Press RETURN with Slide Show mode displayed to return to the Card Menu Screen.

Single Play Mode

Press ▲▼◀▶ to move cursor to desired file in INDEX AREA.

Press OK to display file in full screen size.

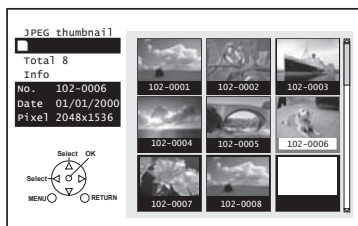

SINGLE VIEW SCREEN

Navigation Display

Pressing RECALL while in Single Play Mode displays or removes the Navigation Area screen.



Navigation Area

Change image

Pressing the ▲▼ buttons changes the displayed image.

Press ▲ : The previous image is displayed.

Press ▼ : The next image is displayed.

Rotate image

Pressing the ◀▶ buttons rotates the image 90° at a time.

Press ▶ : Each press right rotates image 90°.

Press ◀ : Each press left rotates image 90°.

Note:

- Rotation settings are not written to the file and are canceled when Photo Viewer is exited.

Picture Adjustment

When MENU is pressed, the Picture Adjust menu (p. 44) is displayed.

Picture Adjust menu



Pressing RETURN to exit Picture menu.

Exit Single Play mode

Pressing RETURN during Single Play mode allows you to exit the mode.



Press RETURN with Single Play mode displayed to return to the JPEG thumbnail mode.

TV Guide



Press MENU to display the Main Menu screen.

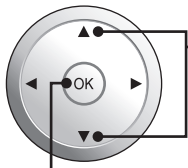

Press to select "TVG/Photo" icon.

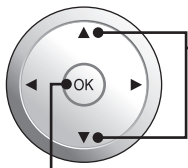

Press to display the TVG/Photo menu.

Press to select "TV Guide".

Press to display the TV Guide.

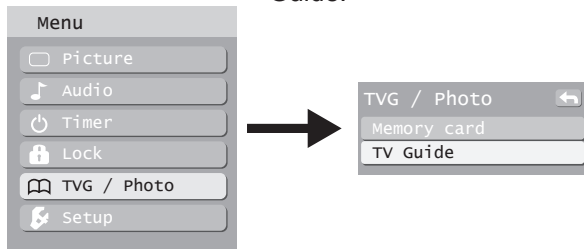

- The TV GUIDE button on remote control or TV set may also be pressed to enter the TV GUIDE.
- When a 1080p (HDMI) signal is received, the Main Menu screen cannot be displayed. (p. 23, 44)

Using TV Guide

TV Guide provides an on-screen listing of shows currently broadcast and to be broadcast over the next one week. Initial setup (p. 28) is required.

1



Press to view TV Guide.

- You can also select "TV Guide" using "TVG/Photo" menu.

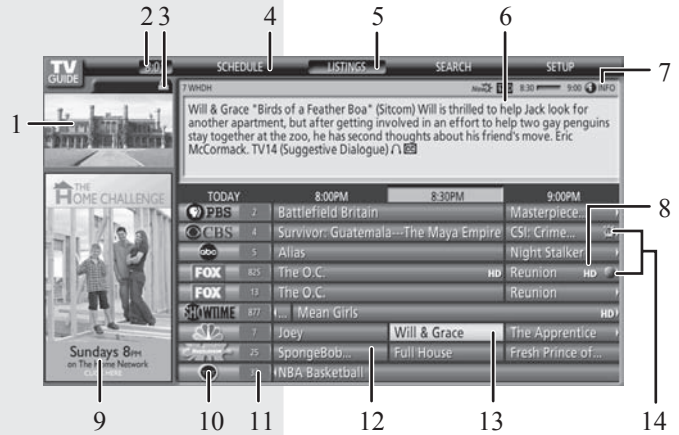

1	Video Window	Displays TV video while the Guide is displayed (can be locked on a single channel or unlocked to preview channels as you navigate LISTINGS and Channel Editor). Note: • Video Window is not displayed when an external input is selected.
2	Clock	Displays current local time.
3	Lock/Unlock icon	Indicates status of the Video Windows.
4	Service Bar	Provides access to the main Guide Services.
5	Current Service Label	Indented to identify the current Service screen.
6	Info Box	Provides information for a highlighted item.
7	Info Icon	Indicates you can press INFO or INFO to cycle through the various Info Box sizes or view Help text for a Service.
8	HD Icon	Identifies shows that are broadcast in HDTV.
9	Ad (Menu)	Location where show- or product-specific information appears (Location where on-screen menus appear).
10	Channel Logo	Identifies network.
11	Channel Number	Identifies channel number.
12	Title Tile	Displays show title.
13	Highlight	Indicates an active title.
14	Record & Remind Icons	Indicates you set a recording or reminder event for the show.

2

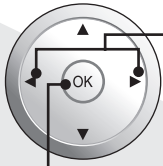

Press to select the menu item from the service bar.

Press to set.



(SCHEDULE/LISTINGS/SEARCH/SETUP)

<p>SCHEDULE</p>		<p>Checks or changes the schedule of recording and reminder reservation and displays what shows have been recorded. (p. 62-63)</p>
<p>SEARCH</p>		<p>Searches for the show by a type and category. (p. 61-62)</p>
<p>LISTINGS</p>		<p>Lists shows of the channel lineup. (p. 59-61)</p>
<p>SETUP</p>		<p>Make changes to existing Guide settings. (p. 61)</p>

■ To display program information or HELP

Press INFO.

■ To scroll pages on TV Guide

Press PAGE \uparrow/\downarrow .

■ To exit TV Guide

Press EXIT or TV GUIDE.

LISTINGS

Watch the show

1



Press to select "LISTINGS" from the service bar.

Press to set.

2

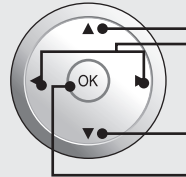

Press to select the show now on the air.

Press to set.



(TV screen)

View details of the show (LISTINGS)

1

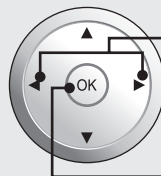

Press to select "LISTINGS" from the service bar.

Press to set.

- Listings is always the first Service displayed in the Guide. Use to move the highlight within Listings to
 - View show listings for today plus 7 days (8 days total)
 - Read show descriptions
 - Tune directly to a show currently airing
 - Set a show to Remind
 - Set a show to Record
 - To lock/unlock the Video Window: Highlight a channel logo on the LISTINGS Service Bar Label and press MENU to display the option to lock/unlock the Video Window.
 - Access Panel and Channel Ads

Further information appears when you select **i** using INFO button

Selected show title



Details

TV Guide (continued)

2



Press to display the Listings Options menu.



video	locked (default)	Video remains on a single channel.
	unlocked	Video changes channels as you navigate the grid.
channel ID	both	Both channel logo and number are displayed in the grid.
	logo	Only channel logo is displayed in the grid.
	number	Only channel number is displayed in the grid.
edit channels	Change the broadcast service that the Guide uses for any channel. Edit the channels that appear in the Guide, reorder their position in the grid, change their tune channel, and, if you have more than one broadcast service, specify the service and input for each channel. You can modify settings directly in the Channel Editor screen.	

Use the Remote Control NUMBER keys to enter the channel number you want to view, or enter the number of hours or days you want to jump ahead or back. The Shortcuts menu appears.

- If you entered a channel number, press OK when the menu appears to jump directly to the channel.
- If you entered a specific number of hours, press ► (jump ahead) or ◀ (jump back) when the menu appears to jump directly to that point.

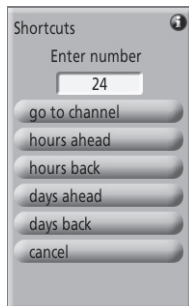

Reserve a show (Recording/Reminder)

1



Press to select "LISTINGS" from the service bar.

Press to set.

2



Press to select the show.

3



Press to display the panel menu.

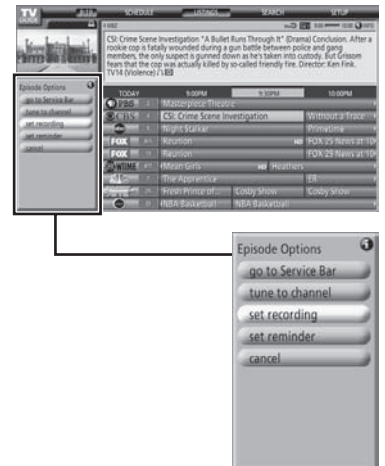

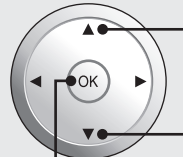

4

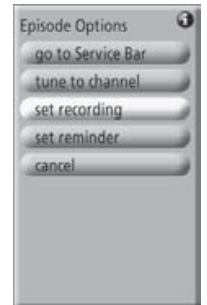

Press to select "set recording" or "set reminder".

Press to set.



5  Press to select and set each setting.

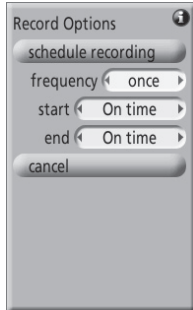

6  Press to set.

■ To check/change/delete reserved contents

Please refer to "SCHEDULE" on page 62.

■ To reserve with input, date, and time

Please refer to "Manual Recording/Manual Reminder" on page 63.

Notes:

- When reserving shows, you must make the proper settings on the external recording equipment connected to the unit.
- Also, read the manual of the recording equipment.

SETUP

Change settings

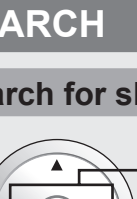
1  Press to select "SETUP" from the service bar.
Press to set.



2 Select an item and follow the on-screen instructions for further settings.

Change system settings	Changes your system settings, selects an alternate channel lineup.
Change channel display	Modifies your channel settings.
Change default options	Changes your Guide default settings.
Display setup progress	Show the Setup Progress screen.

SEARCH

Search for shows

1  Press to select "SEARCH" from the service bar.

Press to set.

2  Press to select a search type.

Press to select a category.

Search type
example: MOVIES, SPORTS...



Category
example: All, Action, Musical...

3  Press to set.

• The show list appears.



Show list

- To display the desired show
→ Select the show on air and press OK.
- To reserve shows for recording
→ Select the upcoming show and press MENU.
→ Select "set recording" on the panel menu.

TV Guide (continued)

■ Searching for a Specific Keyword, Actor, or Director

1. Select "KEYWORD" as the "Search for shows" category in Step 2 and press OK.
2. Select "new search" and press OK.
3. Make the selections for your search and press OK.
 - type (title, actor, director, description, all)
 - category (movies, sports, series, children, HDTV, all, etc.)
 - sub(category) (action, comedy, horror, all, etc.)
4. Select "enter keyword" and press OK.
5. Input the keyword.
 - Press ▲▼◀▶ to select a character.
 - Press OK to input each character.



6. Select "DONE" and press OK.
 - The show list appears.

SCHEDULE

Check reservation

1

2



Recording	Reminder	Description
		Once
		Regularly
		Weekly
		Daily
		Off

From TO DO, press MENU. The Schedule Options menu appears. You can set sort by, new manual recording, new manual reminder.

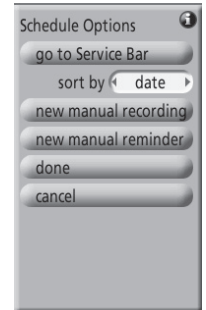

■ To edit/delete reservations

1. Select the reservation.
2. Press MENU.
3. Select on the panel menu.

delete manual recording	Deletes the recording reservation.
edit manual recording	Changes settings of the recording reservation.
delete manual reminder	Deletes the viewing reservation.
edit manual reminder	Changes settings of the viewing reservation.

3

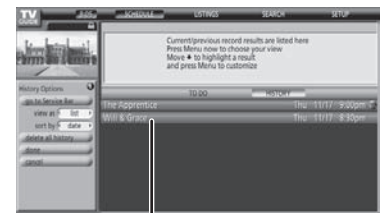

Record results

Current/previous record results are listed here. Press MENU now to choose your view. Move down to highlight a result and press MENU to customize.

Reserve with date and time (Manual Recording/Manual Reminder)

1 Do steps 1~2 to select "TO DO" under "SCHEDULE" on page 62.

2  Press to display the panel menu screen.

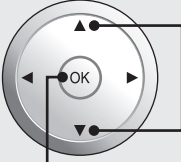
3  Press to select "new manual recording" or "new manual reminder".
Press to display the Record Options screen.

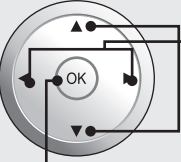
4  Press to select and set the date/time, channel, and other settings.
Press to set the each setting.

(Example: Manual Recording)



Panel menu

Caution:

- A conflict message appears when a show you schedule to
- Record overlaps with any part of another show previously set to record.
 - Record overlaps with a reminder previously set to auto tune.
 - Remind and auto tune overlaps another auto-tune reminder
 - Remind and auto tune overlaps with a scheduled recording.

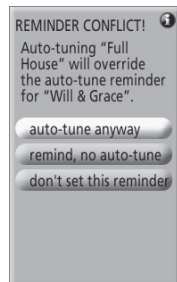
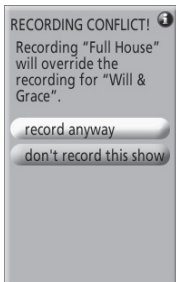

To resolve the conflict, you must select one of these options (which vary according to the type of conflict):

record anyway	Records the specified show and suspends the existing show recording or auto-tune reminder.
don't record this show	Cancels the specified show recording.
auto-tune anyway	Auto tunes the specified show and suspends the existing show reminder set to auto tune.
remind, no auto-tune	Schedules the specified show reminder but cancels the auto-tune option
don't set this reminder	Cancels the specified reminder.

TV Guide (Reminder Screen)

If you skip TV Guide On Screen Setup, a TV Guide Reminder screen will appear the next time you turn on the TV.

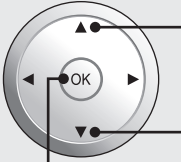
1  Press to highlight an option.
Press to set.



Start setup	Begins setup process.
Remind me to set up later	Closes screen and displays reminder next time you turn on the TV.
Don't remind me again	Closes screen and no further reminder will be displayed.

2  Press to close the screen.

Setup Features

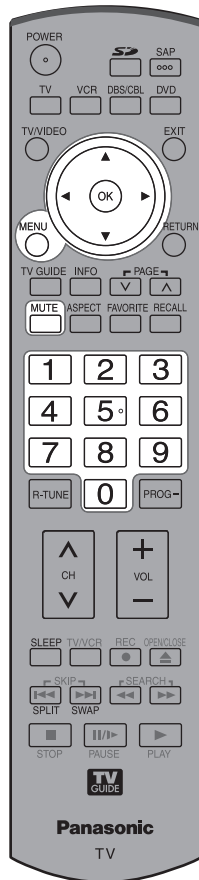

Press MENU to display the Main Menu screen.

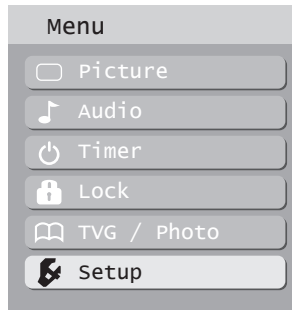
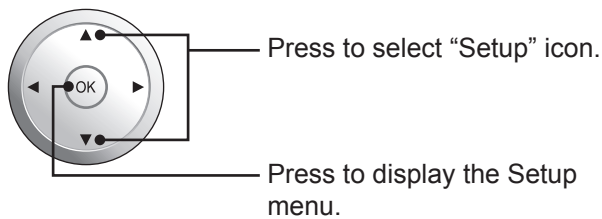

• When a 1080p (HDMI) signal is received, the Main Menu screen cannot be displayed. (p. 23, 44)

CH scan

You may choose the way in which channels are selected with ▲▼.

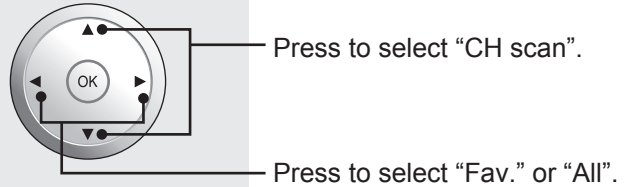

Fav.: ◀▶ only displays programs on the Favorite CH list.

All: ◀▶ selects all channels memorized with Auto Program.

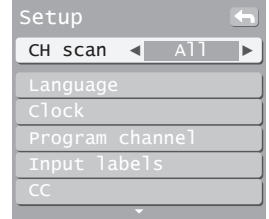

Signal meter

Allows you to confirm the signal strength of a desired channel.

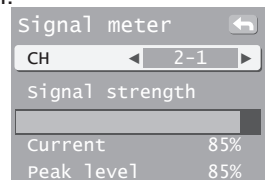
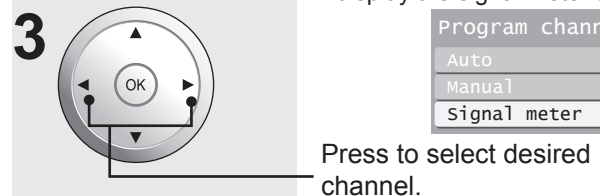
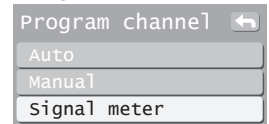
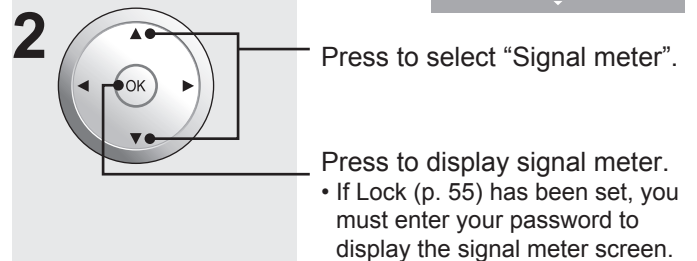
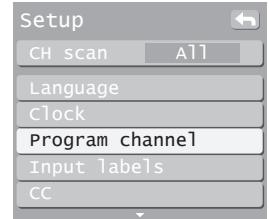
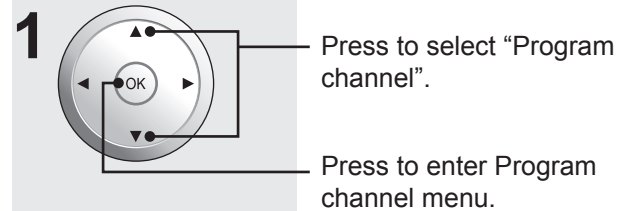

Note:

• The signal meter works only for digital signals input via the antenna.

Input labels

To label video input connections for on-screen display.

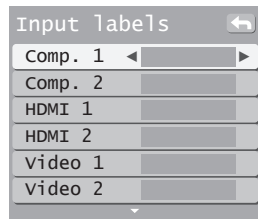
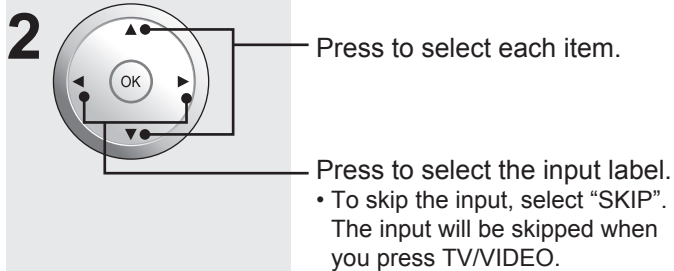
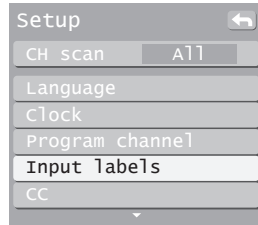
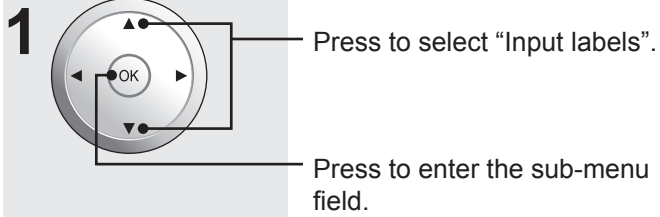

Selectable input labels :
SKIP, VCR, DVD, CABLE, DBS, PVR, GAME, AUX,
blank (non label).

CC (Closed Caption)

The television includes a built-in decoder that is capable of providing a visual display of the audio portion. The program viewed must provide Closed Caption (CC) for the television to display it.

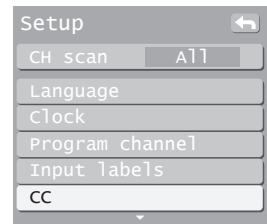
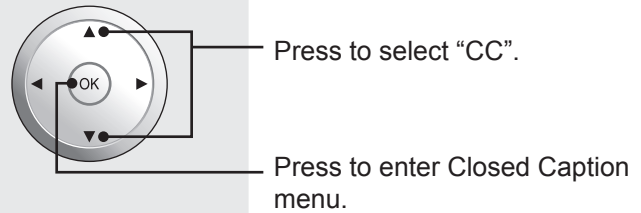

CC Mode

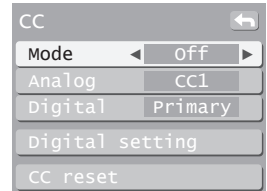
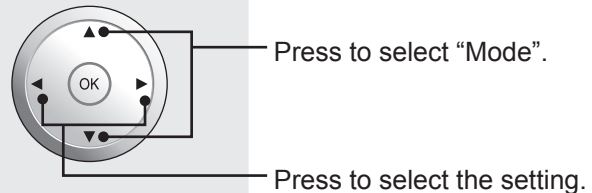

Off : Recommended mode when Closed Caption is not being used.

On : To display Closed Captions.

Notes:

- The closed caption is not displayed when you use HDMI connection.
- The closed caption is not displayed when you use Split Screen mode.
- If analog connected equipment is used for displaying or recording, closed caption (CC) should be set On/Off on the connected equipment.

The CC mode setting of the TV will not affect the analog input.

If a digital program is being output in analog format, the CC data will also be output in analog format.

If digital connected equipment is used for input, CC should be set "On" on either the connected equipment or the TV.

If CC is set "On" on both the connected equipment and the TV, captions from each unit will overlap.

Setup Features (continued)

CC Mode for Analog

Choose the closed caption service of Analog broadcasting.

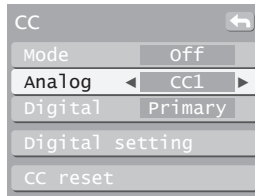
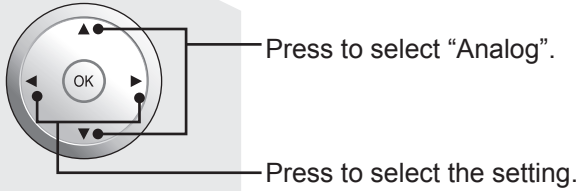

CC1	For video related information that can be displayed (up to 4 lines of script on the screen, where it does not disturb the relevant parts of the picture). Script can be in any language.
CC2/CC3/CC4	Other modes used for video related information.
T1	Blanks out a large portion of the picture on the television screen, and displays program guide or any other information currently being transmitted.
T2/T3/T4	Other modes that display information and blank out a large portion of the picture of the TV screen.

CC Mode for Digital

The Digital Closed Caption menu lets you configure the way you choose to view the digital captioning.

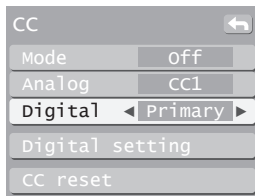
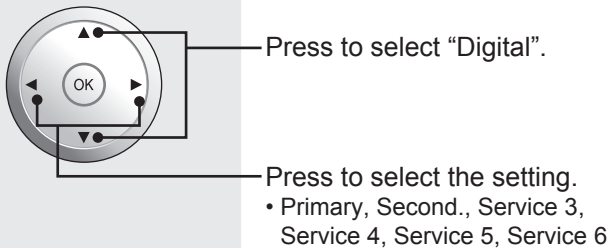

Digital settings

Selecting digital broadcast service and viewing formats.

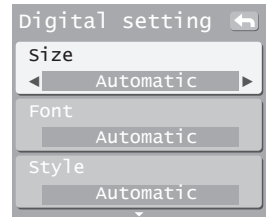
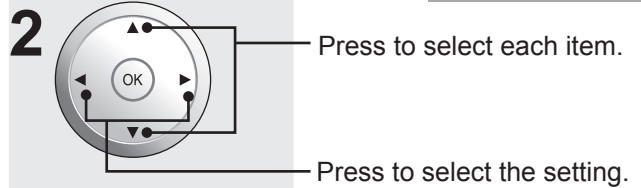
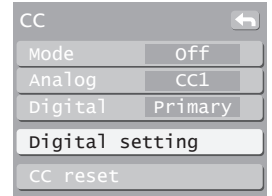
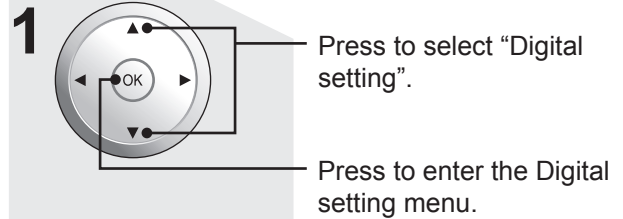

Size	Automatic, Normal, Small, Large
Font	Automatic, Default, Mono-serif, Prop-serif, Mono, Prop, Casual, Cursive, Small caps
Style	Automatic, None, Raised, Depressed, Uniform, Drop shadow

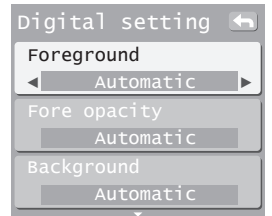

Foreground	The color of the font (Automatic, Black, White, Red, Green, Blue, Yellow, Magenta, Cyan)
Fore opacity	The opacity of the font (Automatic, Transparent, Translucent, Solid, Flashing)
Background	The color of the text box (Automatic, Black, White, Red, Green, Blue, Yellow, Magenta, Cyan)

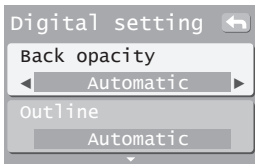

Back opacity	The opacity of the text box (Automatic, Transparent, Translucent, Solid, Flashing)
Outline	The outline of the text (if selected under style) (Automatic, Black, White, Red, Green, Blue, Yellow, Magenta, Cyan)

CC Reset

Reset the CC settings.



- Press to select "CC reset".
- Press to reset Closed Caption settings.

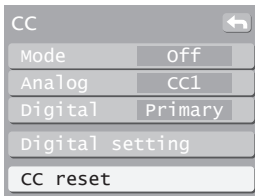

About

Display the TV set Version and Software License.

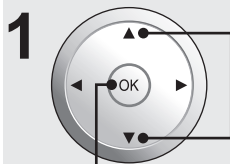

- Press to select "About".
- Press to display the About screen.

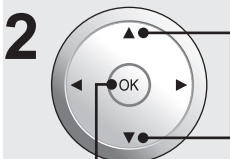
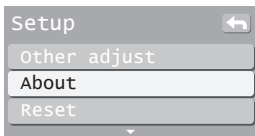

- Press to select "Version" or "License".
- Press to display "Version" or "License".

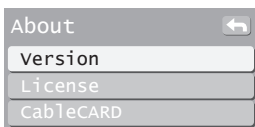

Reset

Setup is reset.

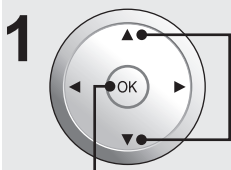

- Press to select "Reset".
- Press to display the password screen.

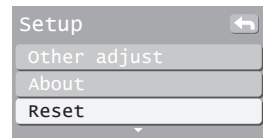

Enter your password by pressing 0 ~ 9 keys to reset the Setup settings.

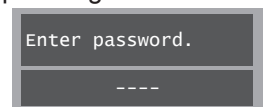

The confirmation screen is displayed. Select "Yes", and press OK.

Notes:

- Performing Reset will clear all items set with Setup, such as channel settings. Use Reset with care.
- When using "Control with HDMI (HDAVI Control)", with the device connected, set "Ctrl with HDMI" first to "Off" and then "On" using the Setup Menu. (p. 68)
- POWER indicator flashes red. After flashing stops, unplug the unit then plug it back in and turn power ON.

Setup Features (continued)

Control with HDMI "HDAVI Control"*

* Simultaneously controls all Panasonic "HDAVI Control" equipped devices with one-button operation using a single remote.

Newer Panasonic audio-video products with HDMI output connections can be controlled using the TV's remote. Limited features, such as home theater system volume control and automatic switching to the TV's HDMI input are possible.

- This feature is limited to models with Panasonic's "Control with HDMI". Refer to the individual instruction manuals for compatibility information.
- Non-HDMI-compliant cables cannot be utilized.
- We recommend using Panasonic HDMI cables RP-CDHG15 (1.5 m), RP-CDHG30 (3.0 m), RP-CDHG50 (5.0 m), etc. (Product numbers correct as of January 2006.)

Notes:

- "Control with HDMI" function does not work in countries other than the USA and Canada.
- Before using HDMI control functions, the connected equipment (DIGA, RAM theater, Player theater, AV amp) must also be set. For details, see the operation manual for each device.
- For equipment connection details, see pages 21-23.

- Set up the equipment, using its manual, to enable this function.
- Turn the TV on again, with the equipment on, when connection or setup is changed.
- This function may not work properly depending on the equipment condition.
- The equipment can be operated by the TV's remote, with this function on, even if the TV is in Standby mode.
- Image/sound may not function for the first few seconds of playback.
- Image/sound may not function for the first few seconds after Input mode is switched.
- Volume function will be displayed when adjusting the volume of the equipment.
- Easy playback is also available by using the remote of the Amplifier. Read the Amplifier manual.

1

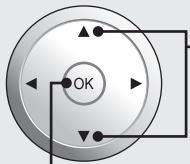

Press to select "Other adjust".

Press to display the Other adjust menu.

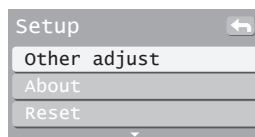

2

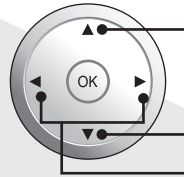

Press to select "Ctrl with HDMI".

Press to select "On".

- Default setting is "On". If no HDMI devices are connected or standard HDMI (without "Control with HDMI") is used, set to "Off".

Other adjust	↩
Prog-out stop	Off
Ctrl with HDMI	On
Power off link	Set
Power on link	No

3

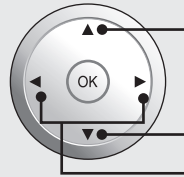

Press to select each item.

Press to select the setting.

Item	Explanations
Ctrl with HDMI	Controls equipment connected to HDMI terminal. (p. 21-23) • "Power off link" and "Power on link" do not work if "Off" is selected.
Power off link	When "Set" is selected, the TV can turn off and on the connected home theater/RAM theater/player theater and/or DIGA-DVD player.
Power on link	When "Set" is selected, the TV can automatically turn on and switch to the appropriate HDMI input whenever a "Control with HDMI" compatible DVD player/recorder is initially turned on or Play mode is selected. • While the power lamp is blinking, the picture cannot be seen. • Power on link will not work until lamp cooling is completed when power is turned off.

Note:

- When the HDMI connection is changed, set "Ctrl with HDMI" first to "Off" and then "On" using the Setup Menu. (p. 21-23)

Automatic Input Switching

At the start of DIGA/Player theater/RAM theater playback, TV input automatically switches to the input compatible with playback equipment.

- For RAM theater, the speakers automatically switch to theater.

If using DIGA operation and the DIGA menu is displayed, the TV input automatically switches to DIGA. If TV power is Off, it switches On.

Theater Speaker

You can control the theater speaker with this unit's Remote Control.

"Home theater" with speaker icon appears when a Panasonic "Control with HDMI" home theater system is connected via the HDMI1 input.

Pressing the OK button toggles between TV and home theater volume control.

- "Ctrl with HDMI" must be set to "On".
- Limited to newer Panasonic Home Theater, RAM theater and DIGA/DVD models with "Control with HDMI".

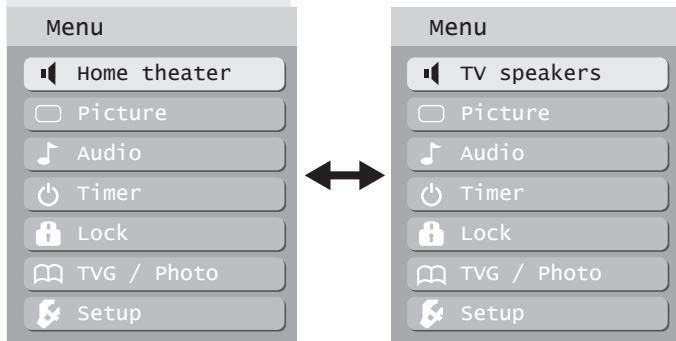
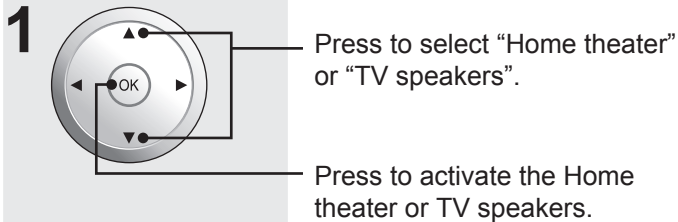

■ Home theater:

Adjustment for Panasonic Amplifier, Panasonic Player theater, Panasonic RAM theater.

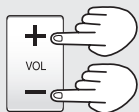

Press for desired volume level.



Press to mute the sound.

■ TV speakers:

The TV speakers are active.

Notes:

- Selecting "Home theater" mutes TV speaker sound.
- When "Home theater" is selected, the home theater volume control can be raised or lowered with the TV remote volume button. The TV displays "Home Theater + / -" on screen.
- If home theater/RAM theater/Player theater is currently off, selecting the "Home theater" option will automatically turn the equipment on.
- Turning off home theater/Player theater/RAM theater automatically switches unit to TV speakers.

One-touch Theater Playback

If the "ONE TOUCH PLAY" key is pressed on the AV amp or Player theater Remote Control, the following sequence of operations is performed automatically.

1. Home theater/Player theater power switches On and playback begins.
2. TV power switches On and the playback screen is displayed.
3. Audio is muted on the TV and switches to theater.

Prog-out stop

When connecting external equipment to this unit - Stops output of the picture and sound signals at the AV OUT jacks for the input source selected in this menu to avoid signal loop.

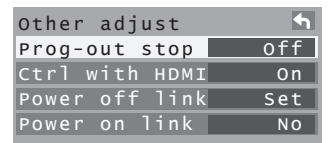
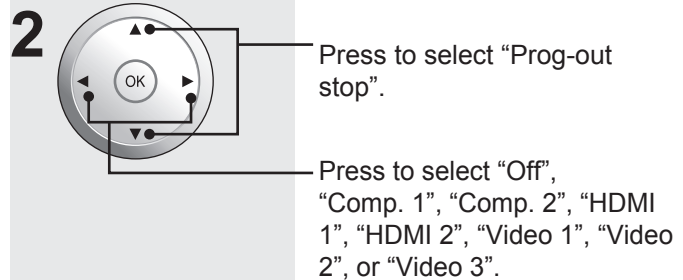
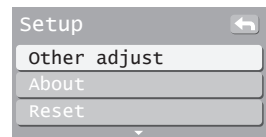
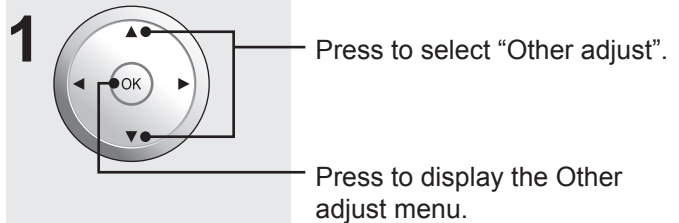

Notes:

- The input signals connected to the terminal selected in "Prog-out stop" menu cannot be output from AV OUT terminals (both picture and audio).
- When recording with a VCR using TV Guide, set "Prog-out stop" setting to the terminal connected the VCR.
- The Prog out will not output picture but can output only sound if the input is either Component or HDMI and when "Prog-out stop" is set to "Off" or other inputs.

Operating Peripheral Equipment

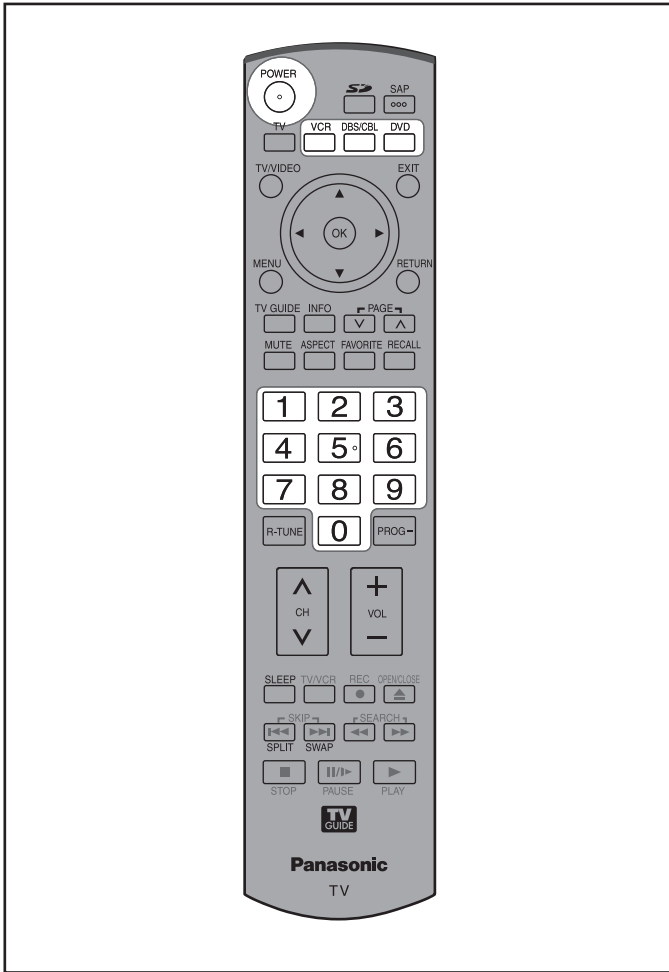

You can operate other manufacturers' components using this unit's Remote Control.

1 Connect the external devices to the Projection Display and turn Off the external devices.

2



+

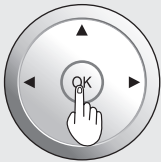

3



Press both buttons simultaneously for more than 3 seconds.

- Release the buttons when the equipment selection buttons start flashing.

Select the equipment with the equipment selection button.

- The selected button remains lit (other buttons are not lit).

4

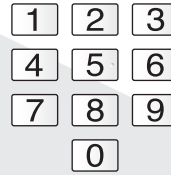

Input the equipment's 4-digit Remote Control code.
(p. 71-74)

5



Confirm the equipment with the Remote Control.

- The external equipment turns On.

■ If the equipment does not operate with Remote Control

- When your equipment has a single code
→ Input the remote control code again
- When your equipment has multiple codes
→ Change the code with step 4 above and test again (p. 72-74)

Caution:

- Registration will fail if the wrong code is input or it takes more than 30 seconds to register.

To find a code not listed in the code list

This procedure searches all codes and is called the "sequence method."

1



+



After step 3 above, change the code and test store.

- Operate the equipment with the Remote Control. (p. 71)
- Repeat until the code is found.
- It may take many attempts before the correct code is found.

2



When the correct code is found.

Remote Control Operation/Code List

The following explains how to operate external devices with the Remote Control.





















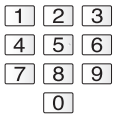

- Register the Remote Control codes (p. 70) if you want to operate an external device of another manufacturer. (p. 72-74)

Note:

- Operation may not be possible depending on the available memory size of the Remote Control.
This Remote Control is not designed to cover operation of all functions of all models.

Remote Control Operation List

This chart defines which keys are operational after programming (if needed), while in the selected Remote Control mode, VCR, DBS/CBL, DVD.

KEY NAME	VCR MODE	DBS/CBL MODE		DVD MODE
		DBS	CBL	
	Power	Power	Power	Power
	TV Input Switch	TV Input Switch	TV Input Switch	TV Input Switch
	–	Exit	Exit	–
	–	OK	OK	OK
	–	DBS Cursor Up/Down/ Right/Left	CBL Cursor Up/Down/ Right/Left	DVD Cursor Up/Down/ Right/Left
	–	DBS Menu	CBL Menu	DVD Setup Menu
	–	–	–	Return, Clear
	TV Mute	TV Mute	TV Mute	TV Mute
	–	Aspect	Aspect	DVD Disc Menu
	–	–	–	Title
	On-screen Display	On-screen Display	On-screen Display	On-screen Display
	0-9	0-9	0-9	0-9
	–	DBS Previous Channel	CBL Previous Channel	Drive Select
	Channel Up/Down	DBS Channel Up/Down	CBL Channel Up/Down	Channel Up/Down
	TV Volume Up/Down	TV Volume Up/Down	TV Volume Up/Down	TV Volume Up/Down
	–	Sleep	Sleep	–
	TV/VCR Switch	TV/DBS Switch	TV/CBL Switch	–
	VCR Record	PVR Record*1	PVR Record*1	Record
	–	Search*1	Search*1	Open/Close
	–	–	–	Skip Reverse/Forward
	Rewind/Fast Forward	–	–	Reverse/Forward
	Stop	–	–	Stop
	Pause	–	–	Pause
	Play	–	–	Play

*1: Combination type

Remote Control Operation/Code List (continued)

Remote Control Code List

Cable Converter

Brand	Code	Brand	Code	Brand	Code	Brand	Code
ABC	0003, 0008	Hamlin	0009, 0273	Philips	0317, 1305	Scientific Atlanta	0008, 0477, 0877, 1877
Americast	0899	Jerrold	0003, 0276, 0476, 0810	Pioneer	0144, 0533, 0877, 1877	Sony	1006
Bell South	0899	Memorex	0000	Pulsar	0000	Starcom	0003
Digeo	1187	Motorola	0276, 0476, 0810, 1187, 1376	Quasar	0000	Supercable	0276
Director	0476	Pace	0008, 0237, 1877	Regal	0273, 0279	Torx	0003
General Instrument	0003, 0276, 0476, 0810	Panasonic	0000, 0107	Runco	0000	Toshiba	0000
GoldStar	0144	Paragon	0000	Samsung	0144	Zenith	0000, 0525, 0899

Satellite Receiver

AlphaStar	0772	General Instrument	0869	Magnavox	0722, 0724	Samsung	1108, 1109, 1142, 1276, 1377, 1442, 1609
Chaparral	0216	GOI	0775, 1775	Memorex	0724	Sanyo	1219
Crossdigital	1109	Goodmans	1246	Mitsubishi	0749	Sony	0639, 1639, 1640
DirecTV	0099, 0247, 0392, 0566, 0639, 0724, 0749, 0819, 1076, 1108, 1109, 1142, 1377, 1392, 1414, 1442, 1443, 1444, 1609, 1639, 1640, 1749, 1856	Hisense	1535	Motorola	0856, 0869	Star Choice	0869
		Hitachi	0819, 1250	NEC	1270	Tivo	1142, 1442, 1443, 1444
		HTS	0775, 1775	Next Level	0869	Toshiba	0749, 0790, 0819, 1285, 1749
		Hughes	0749, 1442, 1749	Panasonic	0152, 0247, 0701, 1786	UltimateTV	1392, 1640
		Hughes Network Systems	0749, 1142, 1442, 1443, 1444, 1749	Paysat	0724	Uniden	0722, 0724
		iLo	1535	Philips	0099, 0722, 0724, 0749, 0819, 1076, 1142, 1442, 1749	US Digital	1535
Dish Network System	0775, 1005, 1170, 1505, 1775	Janeil	0152	Proscan	0392, 0566	USDTV	1535
Dishpro	0775, 1005, 1505, 1775	Jerrold	0869	Pioneer	1442	Voom	0869
Echostar	0775, 1005, 1170, 1505, 1775	JVC	0775, 1170, 1775	Proton	1535	Zenith	1856
Expressvu	0775, 1775	LG	1226, 1414	RadioShack	0869		
GE	0392, 0566			RCA	0143, 0392, 0566, 0855, 1392		

Cable/PVR Combination

Americast	0899	Jerrold	0476, 0810	Pioneer	0877, 1877	Supercable	0276
Digeo	1187	Motorola	0476, 0810, 1187, 1376	Scientific Atlanta	0877, 1877	Zenith	0899
General Instrument	0476, 0810	Pace	0237, 1877	Sony	1006		

DBS/PVR Combination

DirecTV	0099, 0392, 0639, 1076, 1142, 1377, 1392, 1442, 1443, 1444, 1640	Dishpro	0775, 1505	JVC	1170	Samsung	1442
		Echostar	0775, 1170, 1505	Motorola	0869	Sony	0639, 1640
		Expressvu	0775	Philips	1142, 1442	Star Choice	0869
Dish Network System	0775, 1505	Hughes Network Systems	1142, 1442, 1443, 1444	Proscan	0392		
				RCA	1392		

VCR

Brand	Code	Brand	Code	Brand	Code	Brand	Code
ABS	1972	Hewlett Packard	1972	NEC	0067	Scott	0043, 0045
Adventura	0000	Hitachi	0000, 0042, 0089	Nikko	0037	Sears	0000, 0035, 0037, 0042, 1237
Aiwa	0000, 0037, 0124	Howard Computers	1972	Niveus Media	1972	Sharp	0807, 0848
Akai	0175	HP	1972	Northgate	1972	Sonic Blue	0614, 0616
Alienware	1972	Hughes Network Systems	0042, 0739	Olympus	0035, 0226	Sony	0000, 0032, 0033, 0035, 0636, 1032, 1232, 1972
American High	0035	Humax	0739	Onkyo	0222	Stack 9	1972
Audiovox	0037	Hush	1972	Optimus	0037	STS	0042
Broksonic	1479	iBUYPOWER	1972	Orion	1479	Sylvania	0000, 0035, 0043, 1781
Calix	0037	JVC	0067	Panasonic	0035, 0077, 0225, 0226, 0227, 0378, 0616, 1035, 1244	Symphonic	0000
Canon	0035	KEC	0037	Penney	0035, 0037, 0042, 1035, 1237	Systemax	1972
Citizen	0037, 1278	Kenwood	0067	Pentax	0042	Tagar Systems	1972
Craig	0037	Kodak	0035, 0037	Philco	0035	Teac	0000
Curtis Mathes	0035, 0060, 1035	Linksys	1972	Philips	0035, 0618, 0739, 1081, 1181	Technics	0035
CyberPower	1972	Lloyd's	0000	Pilot	0037	Teknika	0000, 0035, 0037
Daewoo	0045, 1278	LXI	0037	Pioneer	0067	Thomas	0000
Dell	1972	Magnasonic	1278	Proscan	0060, 1060	Tivo	0618, 0636, 0739
Denon	0042	Magnavox	0000, 0035, 0039, 1781	Pulsar	0039	Toshiba	0043, 0045, 0845, 1008, 1145, 1972
DirectTV	0739	Marantz	0035	Quasar	0035, 0077, 1035	Totevision	0037
Durabrand	0039	Marta	0037	RadioShack	0000	Touch	1972
Dynatech	0000	Matsushita	0035	Radix	0037	Vector	0045
Electrohome	0037, 0043	Media Center PC	1972	Randex	0037	Video Concepts	0045
Electrohome	0037	MEI	0035	RCA	0042, 0060, 0077, 0807, 0880, 1035, 1060	Videomagic	0037
Emerex	0032	Memorex	0000, 0035, 0037, 0039, 1237	Realistic	0000, 0035, 0037	Viewsonic	1972
Emerson	0000, 0037, 0043, 1278, 1479	MGA	0043	ReplayTV	0614, 0616	Villain	0000
Fuji	0033, 0035	Microsoft	1972	Ricavision	1972	Voodoo	1972
Funai	0000	Mind	1972	Runco	0039	Wards	0000, 0035, 0042, 0060
Garrard	0000	Minolta	0042	Samsung	0045, 0739, 1014	XR-1000	0000, 0035
Gateway	1972	Mitsubishi	0043, 0067, 0807	Sanky	0039	Zenith	0000, 0033, 0039, 1479
GE	0035, 0060, 0807, 1035, 1060	Motorola	0035	Sansui	0000, 0067, 1479	ZT Group	1972
GoldStar	0037, 1237	MTC	0000	Sanyo	0159		
Gradiente	0000	Multitech	0000				
Harley Davidson	0000						

DBS/PVR Combination

Hughes Network Systems	0739	Philips	0739
		Samsung	0739

PVR

ABS	1972	Hughes Network Systems	0739	Niveus Media	1972	Systemax	1972
Alienware	1972	Humax	0739	Northgate	1972	Tagar Systems	1972
CyberPower	1972	Hush	1972	Panasonic	0616	Tivo	0618, 0636, 0739
Dell	1972	iBUYPOWER	1972	Philips	0618, 0739	Toshiba	1008, 1972
DirectTV	0739	Linksys	1972	RCA	0880	Touch	1972
Gateway	1972	Media Center PC	1972	ReplayTV	0614, 0616	Viewsonic	1972
Hewlett Packard	1972	Microsoft	1972	Sonic Blue	0614, 0616	Voodoo	1972
Howard Computers	1972	Mind	1972	Sony	0636, 1972	ZT Group	1972
HP	1972			Stack 9	1972		

Remote Control Operation/Code List (continued)

DVD

Brand	Code	Brand	Code	Brand	Code	Brand	Code
Allegro	0869	GoldStar	0741	Onkyo	0503, 0792	Sensory Science	1158
Apex Digital	0672, 0794, 0796, 0797, 1004, 1056, 1061, 1100	Gradiente	0490	Panasonic	0490, 0503, 0632, 0703, 1010, 1011, 1362, 1462, 1490, 1762, 1967	Sharp	0630, 0675, 0752, 1256
Aspire Digital	1168	Grundig	0539	Philips	0503, 0539, 0646, 0675, 1267, 1354	Shinasonic	0533
Blue Parade	0571	Hitachi	0573, 0664	PianoDisc	1024	Sonic Blue	0869
Broksonic	0695	Hiteker	0672	Pioneer	0525, 0571, 0631, 0632	Sony	0533, 0864, 1033, 1431, 1533
California Audio Labs	0490	Integra	0571	Polaroid	1061, 1086	Sylvania	0675
CineVision	0833, 0869	JVC	0558, 0623, 0867, 1164, 1275	Polk Audio	0539	Symphonic	0675
Coby	1086	Kenwood	0490, 0534	Proceed	0672	Teac	0809
CyberHome	1024, 1129	Lecson	1533	Proscan	0522	Technics	0490, 0703
Daewoo	0833, 0869	LG	0591, 0741, 0801, 0869	RCA	0522, 0571, 0822	Theta Digital	0571
Denon	0490	LiteOn	1158, 1440	Rio	0869	Toshiba	0503, 0695, 1045, 1154
Disney	0675	Loewe	0511	Rotel	0623	Urban Concepts	0503
DVD2000	0521	Magnavox	0503, 0539, 0646, 0675	Sampo	0752	Xbox	0522
Emerson	0591, 0675	Marantz	0539	Samsung	0490, 0573, 0820, 1075	Yamaha	0490, 0539, 0545
Enterprise	0591	McIntosh	1533	Sansui	0695	Zenith	0503, 0591, 0741, 0869
Funai	0675	Memorex	0695	Sanyo	0695, 0873, 1967		
Gateway	1158	Microsoft	0522				
GE	0522	Mitsubishi	0521, 1521				
Go Video	0741, 0833, 0869, 1075, 1158, 1304, 1730	NAD	0591, 0741				
		NEC	0785				

DVD Recorder

Apex Digital	1056	Go Video	0741, 1158, 1304, 1730	Philips	0646	Sensory Science	1158
Aspire Digital	1168	JVC	1164, 1275	Pioneer	0631	Sharp	0675
Coby	1086	LG	0741	Polaroid	1086	Sony	1033, 1431
CyberHome	1129	LiteOn	1158, 1440	RCA	0522	Sylvania	0675
Funai	0675	Magnavox	0646	Samsung	0490	Zenith	0741
Gateway	1158	Panasonic	0490, 1010, 1011				

Warning Indicators

Indicator lights on the front of the unit alert you to the unit's internal condition. (p. 10)

If the Lamp, Power, or Temp indicators flash, turn unit off and follow the directions below.

	Indicator	Symptom	Problem	Possible Solution
TEMP Indicator	Flashes red.	Power shuts off.	Internal overheat error.	Wait a while, then turn unit back on.
POWER Indicator	Flashes orange 1 time.	Power shuts off.	Malfunction 1.	Contact service center.*1
	Flashes orange 2 times.	Power shuts off.	Malfunction 2.	Contact service center.*1
	Flashes orange 3 times.	Power shuts off.	Malfunction 3.	Contact service center.*1
	Flashes orange 5 times.	Power shuts off.	Malfunction 4.	Contact service center.*1
	Flashes orange 6 times.	Power shuts off.	Malfunction 5.	Contact service center.*1
	Flashes orange 7 times.	Power shuts off.	The Lamp Cover is unsecured.	Securely attach Lamp Cover.
	Flashes orange 8 times.	Power shuts off.	Malfunction 6.	Contact service center.*1
	Lights solid orange.	The screen isn't illuminated.	Malfunction 7.	Contact service center.*1
LAMP Indicator	Flashes red 1 time.	Power shuts off.	Lamp will not light or light is abnormal.	Try turning Power On several times. If error persists, contact service center.
	Flashes red 2 times.	Dynamic iris off.	Malfunction 8.	Contact service center.
	Flashes red 3 times.	Dynamic iris off.	Malfunction 9.	Contact service center.
	Flashes red 4 times.	Dynamic iris error.	Malfunction 10.	Contact service center.
	Lights solid red.	OSD appears every time power is turned on.	Maximum Lamp life hours exceeded.	Replace Lamp.

*1: Press unit POWER button down over 7 seconds. The POWER indicator goes out. Turn Power back On after 5 seconds. If the warning indicator still does not go out, please contact a service center.

Note:

- Once necessary steps have been taken, and before turning unit back On, be sure the unit has sufficiently cooled down. Especially if the unit was used for a long period, the lamp may take a while to cool down.

Replacing the lamp unit

The lamp unit is sold separately. To purchase a replacement, call the Panasonic accessory department, toll free at: 1-800-332-5368.
Lamp unit Part No. : TY-LA2006

Lamp unit replacement period

The Lamp is a consumable item and its life varies based on individual usage. Panasonic warrants the original Lamp for a period of 18 months from the date of purchase of the TV. Replacing the lamp is so easy that you can do it yourself. For the lamp replacement procedure, please see the next page.

- The unit will detect when the Lamp's end of life is approaching and the message (shown at right) will be displayed.
- The LAMP indicator light will be lit when the Lamp's end of life is approaching.

The lamp needs to be replaced, and the lamp hour meter needs to be reset.

Influences of frequent lighting, continuous light use for over 24 hours, the number of times lit, the length of time between lightings, etc. may shorten lamp life. (Because of this, we recommend having a replacement lamp on hand.)

WARNING

Failure to follow these warnings when replacing the lamp unit could result in personal injury:

- 1) The lamp could rupture if dropped and lamp fragments could cause injury.
- 2) Because the lamp unit is hot immediately after its use, touching it may cause burns. Please allow the lamp to cool before handling or replacing the lamp unit.
- 3) If replacement of the lamp unit becomes necessary during the operation of the Projection Display, follow the procedure below.
 - a. Press the POWER button on the Remote Control to turn off the power.
 - b. Wait for about 1 minute until the cooling fan stops.
 - The lamp cooling fan will continue to operate for about 1 minute after turning off the power. Do not unplug the power cord from the outlet until the fan has stopped. Avoid interrupting the power line by using circuit breakers or switchable power strips.
 - c. After the cooling fan has stopped, Disconnect the power cord from the outlet.
 - d. Please wait more than one hour to let the lamp cool before replacing it.
 - e. **[If you need to replace the lamp more urgently]**
 - The Projection Display has a forced cooling feature. After the POWER button is turned OFF, and during the first minute of the normal cooling fan operation, press the VOL+ button on the Projection Display and the CH ^ button on the Remote Control at same time for more than 5 seconds. The cooling fan operates for about 10 minutes. The LAMP indicator flashes red 5 times every 5 seconds.

CAUTION

Because of the possibility of injury, strictly follow the replacement procedure on the next page.

This product has a High Intensity Discharge (HID) lamp that contains a small amount of mercury. Disposal of these materials may be regulated in your community due to environmental considerations. For disposal or recycling information please contact your local authorities, or the Electronics Industries Alliance: <<http://www.eiae.org>>

Lamp replacement procedure

- 1 Turn power off, wait until power indicator stops blinking red, then disconnect the power cord from the wall outlet and confirm that the area around the lamp unit has cooled down.

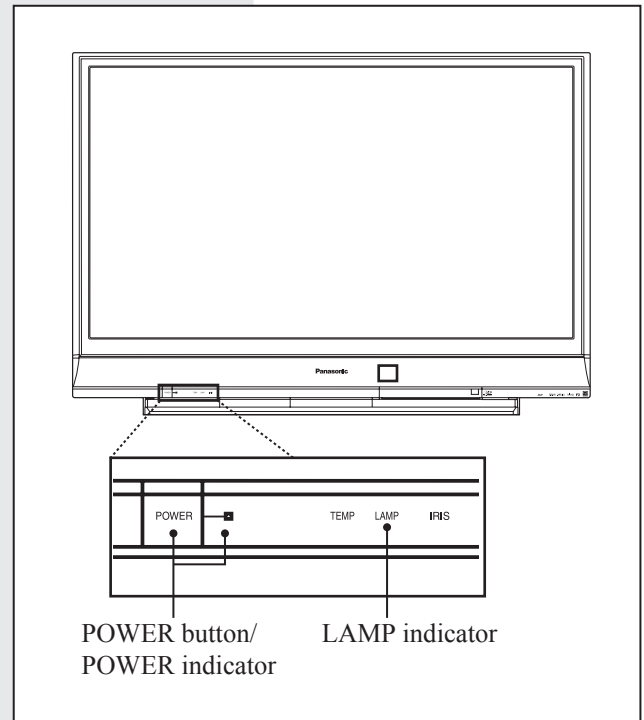

- Please wait more than one hour for lamp replacement. If you need to replace the lamp more urgently, please see "e" at left.

Note:

- Remove Front Cover after Front Door (p. 10) is opened.

2 Pull on both ends of the Front Cover ❶ with your fingertips to remove it.

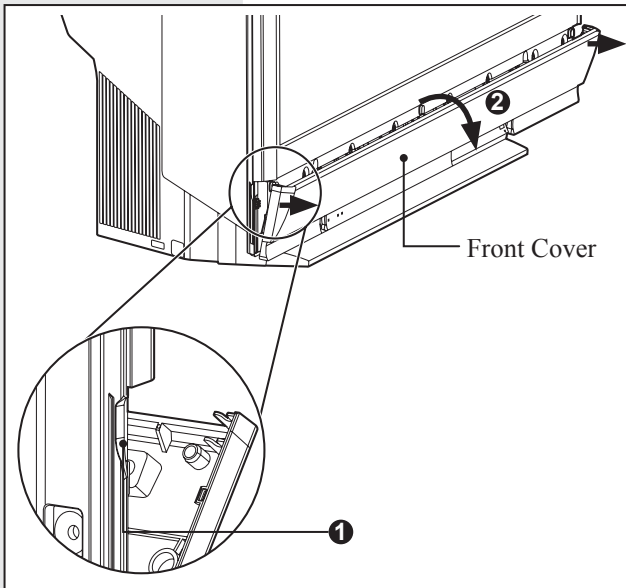

3 (1) Turn the Lamp Cover Lock/Open Knob to the left.
(2) Pull the Lamp Cover out and down to open it.

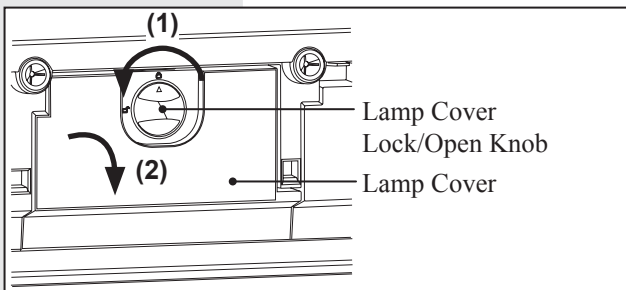

4 (1) Turn the Lamp Unit Lock/Open Knob to the left.
(2) Grasp the Lamp Unit Lock/Open Knob and slowly remove the Lamp Unit as shown.

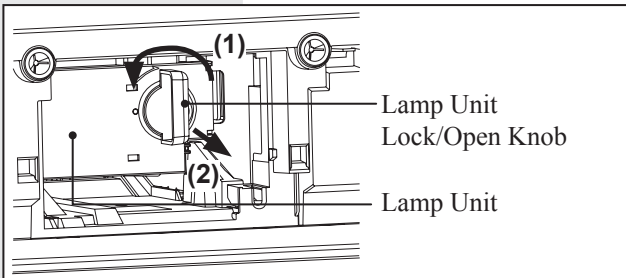

⚠ CAUTION

- The Lamp Unit is hot right after use and may cause burns if touched.
- Please allow the Lamp Unit to cool before handling or replacing it.

5 (1) Insert the new Lamp Unit being careful of the insertion direction.
• Press on the arrow mark to confirm proper insertion.
(2) Turn the Lamp Unit Lock/Open Knob to the right until it clicks.

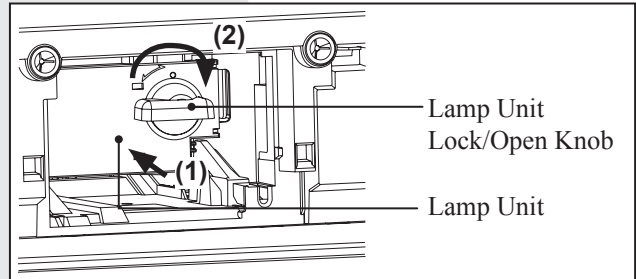

Notes:

- Properly dispose of the old lamp. Please see page 76.
- Secure the Lamp Unit and Lamp Unit housing door. If they are not secured, a protective circuit will not allow the lamp to turn on.
- At this point, confirm that the Lamp Unit will not come out by pulling on the Lamp Unit Lock/Open Knob.

6 (1) Close the Lamp Cover.
(2) Turn the Lamp Cover Lock/Open Knob to the right.

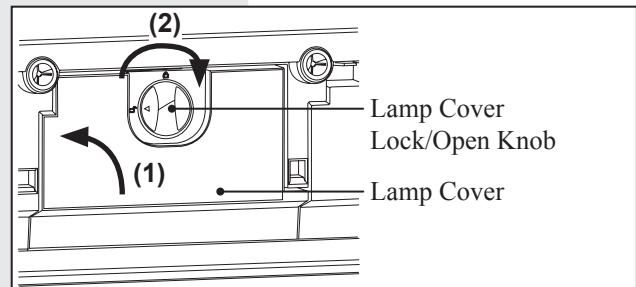

7 Be sure that the Hook on the Front Cover is securely fastened to the unit as shown.

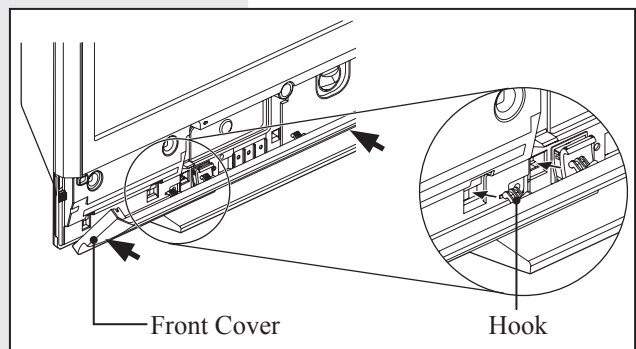

After lamp replacement, you must reset the lamp time. Refer to the instructions enclosed with the lamp unit (Part No.: TY-LA2006).

Troubleshooting

Before you call for service, determine the symptoms and make a few simple checks as shown below.

Symptoms		Checks	Page
Power does not turn ON.		<ul style="list-style-type: none"> Is the power cord plugged in? The lamp cover is ajar. Firmly replace the cover. 	26
Remote Control/ Unit buttons do not function. Power does not turn ON or OFF. Image is distorted. Image freezes.		<ul style="list-style-type: none"> Press unit POWER button down over 7 seconds. The POWER indicator goes out. If the Power was On, the screen will also disappear. After 5 seconds, turn Power On and operate unit normally. If the steps above do not restore normal operation, disconnect then reconnect the AC plug and turn the power On. 	-
No picture even if the power is turned ON. LAMP indicator blinks red.		<ul style="list-style-type: none"> Please replace lamp with a new one. Please consult your nearest dealer, if problem persists. 	76-77
The power turns OFF.	The TEMP indicator flashes red.	<ul style="list-style-type: none"> Check whether or not the vents are clogged. Is the set being used in a location that is hot? 	75
	Power turns off while another indicator is flashing.	<ul style="list-style-type: none"> Please consult your nearest dealer. 	75
Remote Control does not function.		<ul style="list-style-type: none"> Are the batteries dead or inserted incorrectly? 	7
		<ul style="list-style-type: none"> Is the Remote Control sensor in direct fluorescent lamp light or other strong sources of light? 	10
		<ul style="list-style-type: none"> Did you correctly set the Remote Control code? 	70-74
Image shakes.		<ul style="list-style-type: none"> Is the antenna or antenna cable old, broken, or shorted out? 	-
Image is not clear. (blurring / vertical lines)		<ul style="list-style-type: none"> Is the antenna cable connected properly? 	12-14
		<ul style="list-style-type: none"> A sudden temperature change may have caused condensation in the internal optics which results in blurring or vertical lines. Please wait until room temperature is normal and constant before turning power ON. These symptoms will clear up as time passes. 	-
		<ul style="list-style-type: none"> Depending on the connected device, a 1080i input signal may cause the picture to flicker. If the connected device has a format selection switch, set the format to 720p. 	-
Color patches or no color.		<ul style="list-style-type: none"> When using a VCR and selecting channels on the TV, is the TV/ VIDEO mode for the VCR set to TV? 	-
Image appears doubled or tripled.		<ul style="list-style-type: none"> Is the antenna facing the right direction? 	-
		<ul style="list-style-type: none"> Is the antenna receiving any signals reflected off of mountains or buildings? 	-
Images disappear at the top and bottom of the screen.		<ul style="list-style-type: none"> When using 16:9 image software (cinema vision size software, etc.), there is no picture at the top and bottom of the screen. 	-
During ZOOM modes, the image is cut off at the top and bottom.		<ul style="list-style-type: none"> Please adjust the V-Size. This is not a malfunction. 	45
The Projection Display set makes a high whistling sound when the power is ON.		<ul style="list-style-type: none"> This is the sound of the internal Starting UP. This is not a malfunction. 	-
Some parts of the screen are always lit while others do not light up. Some parts of the screen do not light up.		<ul style="list-style-type: none"> This is a characteristic of the DMD and not a malfunction. 	-
Fan is operating even though TV Power is OFF.		<ul style="list-style-type: none"> This is because the cooling fan is operating. The fan will stop after about 1 minute. 	26
An OSD instructing to replace the lamp is displayed. (The LAMP indicator is lit red.)		<ul style="list-style-type: none"> Replace lamp with a new one. 	76-77
Relighting the lamp when it is hot makes a sound.		<ul style="list-style-type: none"> This is a characteristic of the lamp and not a malfunction. 	-

Symptoms	Checks	Page
Ghost images on screen. This may occur if stationary images, such as still video images, web pages, or filler bars (used for NORMAL aspect mode), are left on-screen for a prolonged time.	<ul style="list-style-type: none"> This is a characteristic of the DMD and not a malfunction. Try displaying constantly moving pictures which fill the entire screen, or turn the power OFF for a while to return the screen to normal. 	-
An OSD advising "AIR FILTER CLEANING..." is displayed.	<ul style="list-style-type: none"> Please consult your nearest dealer. 	-
When viewing with HDMI connection, picture is displayed with unnatural colors (as if red and blue are reversed).	<ul style="list-style-type: none"> Change "Color corr." from "Off" to "On". 	46
Pictures from equipment connected via HDMI are abnormal.	<ul style="list-style-type: none"> Is the HDMI cable connected properly? 	21-23
	<ul style="list-style-type: none"> Turn the TV unit and the device Off, then On again. 	-
	<ul style="list-style-type: none"> Check the input signal from the equipment. 	37
No sound is produced.	<ul style="list-style-type: none"> Is "Sound Mute" active? 	39
	<ul style="list-style-type: none"> Is the volume set to minimum? 	38
	<ul style="list-style-type: none"> Is "Speakers" set to "Off"? 	48
	<ul style="list-style-type: none"> Change "SAP" settings. 	40
	<ul style="list-style-type: none"> Check "HDMI1 in" or "HDMI2 in" settings when equipment is connected via HDMI. 	48
	<ul style="list-style-type: none"> If there is a problem with digital sound connection, select analog sound connection. 	21-23, 48
Show list disappears after blackout in TV Guide.	<ul style="list-style-type: none"> The list will be downloaded within 24 hours. 	-
Channel display is not correct in TV Guide.	<ul style="list-style-type: none"> Set to the correct channel in "Change Channel Display". 	61
Unable to execute a scheduled recording in TV Guide.	<ul style="list-style-type: none"> Is VCR turned "Off"? 	-
	<ul style="list-style-type: none"> Is a videocassette inserted? 	-
	<ul style="list-style-type: none"> Check "Schedule" to see if show is set in the list. 	62
	<ul style="list-style-type: none"> Check the position of IR Blaster. 	20
Unable to receive the scheduled broadcast in TV Guide.	<ul style="list-style-type: none"> Check "Schedule" to see if show is set in the list. 	62
	<ul style="list-style-type: none"> Check the installation of IR Blaster. 	20
No show list appears in TV Guide.	<ul style="list-style-type: none"> Has it been 24 hours since completing the initial setup of TV Guide? (Some time is required for list downloading.) 	-
	<ul style="list-style-type: none"> After initial settings, it takes about a week to display the entire list for 8 days. 	-
	<ul style="list-style-type: none"> Check the connection of the TV, cables, and antenna. 	-

Specifications



		PT-56DLX76	PT-61DLX76/PT-61DLX26
Power Source		AC 120 V, 60 Hz	
Power Consumption		Power ON: Approx. 220 W (When audio is at maximum) Power OFF: Approx. 0.5 W (When cooling fan is stopped with no CableCARD™)	
DMD elements	Element Size	0.65" (Aspect ratio: 16:9)	
	Display method	Single Chip DMD element, DLP™ system	
	No. of pixels	Resolution: 1 920 × 1 080	
Display		56-inch, 16 : 9 aspect ratio	61-inch, 16 : 9 aspect ratio
Speaker		30 W [7.5 W + 7.5 W + 15 W (subwoofer)] (10 % THD)	
HID Lamp		120 W HID (High Intensity Discharge) Lamp	
Channel Capability (Digital/Analog)		VHF/UHF Cable	2-69 1-135
Input Terminals	PC INPUT	RGB analog AUDIO	0.7 Vp-p (75 Ω) (D-SUB 15P) 0.5 Vrms (M3 Stereo mini Pin Jack)
	AV INPUT 1-3	VIDEO S-VIDEO AUDIO L-R	1.0 Vp-p (75 Ω) (RCA Pin Jack) Y : 1 Vp-p (75 Ω), C : 0.286 Vp-p (75 Ω) (Mini DIN 4 pin) 0.5 Vrms (RCA Pin Jack × 2)
	COMPONENT VIDEO INPUT 1-2	Y P _B / P _R AUDIO L-R	1.0 Vp-p (with sync) (75 Ω) (Pin Jack) ± 0.35 Vp-p (75 Ω) (Pin Jack × 2) 0.5 Vrms (RCA Pin Jack × 2)
	HDMI 1-2	HDMI type A Connector AUDIO L-R	0.5 Vrms (RCA Pin Jack Type × 2)
SD Card slot		SD Card (8 MB/ 16 MB/ 32 MB/ 64 MB/ 128 MB/ 256 MB/ 512 MB/ 1 GB/ 2 GB (Maximum))	
Output signals (AV OUT)		VIDEO AUDIO L-R	1.0 Vp-p (75 Ω) (RCA Pin Jack) 0.5 Vrms (RCA Pin Jack × 2)
IR Blaster		G-LINK Jack × 1	
Tuner		ATSC digital tuner with digital cable module	
Dimensions (W × H × D)		1 321 mm (W) × 925 mm (H) × 446 mm (D) 52" (W) × 36-7/16" (H) × 17-9/16" (D)	1 431 mm (W) × 999 mm (H) × 479 mm (D) 56-5/16" (W) × 39-5/16" (H) × 18-7/8" (D)
Weight (Mass)		34 kg (75 lbs.) Net	37 kg (81.6 lbs.) Net
Operating conditions		Temperature : 0 °C – 35 °C (32 °F - 95 °F) Humidity : 20 % - 80 % (non-condensing)	

Note:

- Design and Specifications are subject to change without notice. Weight and Dimensions shown are approximate.

Cleaning

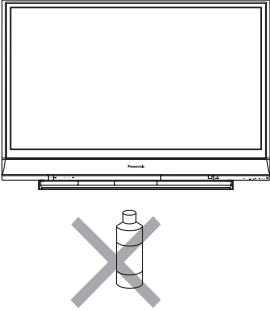
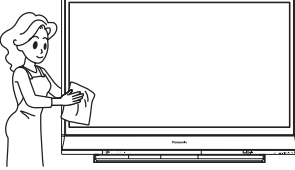
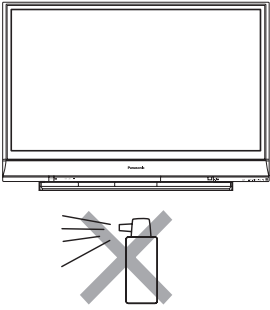
To ensure continued excellent performance by this product, periodic cleaning is recommended.

	<p>The unit contains many plastic parts. For this reason DO NOT use benzine, thinner or other chemicals to clean the unit.</p>		<p>Dust will accumulate on the picture screen. Please wipe with a soft cloth from time to time. If you use a chemically treated cloth, please be careful to follow the instructions that come with the cloth.</p>
	<p>DO NOT bring into contact with insecticide or other volatile substances. DO NOT allow the unit to come into contact for extended periods with rubber or vinyl products.</p>		<p>Remove dirt and soiling by wiping with a light cloth. Even if the unit is heavily soiled, do not apply cleaner directly to the unit. Soak a cloth in a solution of neutral cleanser diluted with water. Then wring out the cloth, wipe the unit clean, and finish by wiping with a dry cloth. Do not use any type of cleansers on the picture screen.</p>

Customer Services Directory

Obtain Product Information and Operating Assistance; locate your nearest Dealer or Servicer; purchase Parts and Accessories; or make Customer Service and Literature requests by visiting our Web Site at:

<http://www.panasonic.com/consumersupport>

or, contact us via the web at:

<http://www.panasonic.com/contactinfo>

You may also contact us directly at:

1-800-211-PANA (7262),

Monday-Friday 9 am-9 pm; Saturday-Sunday 10 am-7 pm, EST.

For hearing or speech impaired TTY users, TTY : 1-877-833-8855

Accessory Purchases

Purchase Parts, Accessories and Instruction Books online for all Panasonic Products by visiting our Web Site at:

<http://www.pasc.panasonic.com>

or, send your request by E-mail to:

npcparts@us.panasonic.com

You may also contact us directly at:

1-800-332-5368 (Phone) 1-800-237-9080 (Fax Only) (Monday – Friday 9 am to 9 pm, EST.)

Panasonic Services Company

20421 84th Avenue South,

Kent, WA 98032

(We Accept Visa, MasterCard, Discover Card, American Express, and Personal Checks)

For hearing or speech impaired TTY users, TTY : 1-866-605-1277

Service in Puerto Rico

Panasonic Puerto Rico, Inc. Panasonic Sales Company

Factory Servicer:

Ave. 65 de Infantería, Km. 9.5, San Gabriel Industrial Park, Carolina, Puerto Rico 00985

Phone (787)750-4300 Fax (787)768-2910

Limited Warranty

PANASONIC CONSUMER ELECTRONICS COMPANY,
DIVISION OF PANASONIC CORPORATION OF NORTH
AMERICA
One Panasonic Way Secaucus, New Jersey 07094

PANASONIC SALES COMPANY, DIVISION OF PANASONIC
PUERTO RICO, INC.,
AVE. 65 de Infantería, Km. 9.5 San Gabriel Industrial Park,
Carolina, Puerto Rico 00985

Panasonic Multimedia Projection HDTV Limited Warranty

Limited Warranty Coverage

If your product does not work properly because of a defect in materials or workmanship, Panasonic Consumer Electronics Company or Panasonic Sales Company (collectively referred to as “the warrantor”) will, for the length of the period indicated on the chart below, which starts with the date of original purchase (“warranty period”), at its option either (a) repair your product with new or refurbished parts, or (b) replace it with a new or a refurbished product. The decision to repair or replace will be made by the warrantor.

CATEGORY	PARTS	LABOR	SERVICE
Multimedia Projection HDTV	One (1) Year except lamp Original Lamp-18 months	One (1) Year	In-Home or Carry-In

During the “Labor” warranty period there will be no charge for labor. During the “Parts” warranty period, there will be no charge for parts. You must carry-in your product or arrange for in-home service during the warranty period. If non-rechargeable batteries are included, they are not warranted. This warranty only applies to products purchased and serviced in the United States or Puerto Rico. This warranty is extended only to the original purchaser of a new product which was not sold “as is”. A purchase receipt or other proof of the original purchase date is required for warranty service.

Carry-in or In-Home Service

For In-Home or Carry-In Service in the United States call 1-888-VIEW-PTV (1-888-843-9788).

For assistance in Puerto Rico call Panasonic Sales Company (787)-750-4300 or fax (787)-768-2910.

In-Home service requires clear, complete and easy access to the product by the authorized servicer and does not include removal or re-installation of an installed product. It is possible that certain in-home repairs will not be completed in-home, but will require that the product, or parts of the product, be removed for shop diagnosis and/or repair and then returned.

Limited Warranty Limits And Exclusions

This warranty ONLY COVERS failures due to defects in materials or workmanship, and DOES NOT COVER normal wear and tear or cosmetic damage. The warranty also does not cover damages which occurred in shipment, or failures which are caused by products not supplied by the warrantor, or failures which result from accidents, misuse, abuse, neglect, bug infestation, mishandling, misapplication, alteration, faulty installation, set-up adjustments, misadjustment of consumer controls, power line surge, lightning damage, modification, or commercial use (such as in a hotel, office, restaurant, or other business), rental use of the product, service by anyone other than a Factory Servicenter or other Authorized Servicer, or damage that is attributable to acts of God.

THERE ARE NO EXPRESS WARRANTIES EXCEPT AS LISTED UNDER “LIMITED WARRANTY COVERAGE”. THE WARRANTOR IS NOT LIABLE FOR INCIDENTAL OR CONSEQUENTIAL DAMAGES RESULTING FROM THE USE OF THIS PRODUCT, OR ARISING OUT OF ANY BREACH OF THIS WARRANTY. (As examples, this excludes damages for lost time, cost of having someone remove or re-install an installed unit if applicable, or travel to and from the servicer. The items listed are not exclusive, but are for illustration only.) **ALL EXPRESS AND IMPLIED WARRANTIES, INCLUDING THE WARRANTY OF MERCHANTABILITY, ARE LIMITED TO THE PERIOD OF THE LIMITED WARRANTY.**

Some states do not allow the exclusion or limitation of incidental or consequential damages, or limitations on how long an implied warranty lasts, so the exclusions may not apply to you.

This warranty gives you specific legal rights and you may also have other rights, which vary, from state to state. If a problem with this product develops during or after the warranty period, you may contact your dealer or Servicenter. If the problem is not handled to your satisfaction, then write to the warrantor's Consumer Affairs Department at the addresses listed for the warrantor.

PARTS AND SERVICE (INCLUDING COST OF AN IN-HOME SERVICE CALL, WHERE APPLICABLE) WHICH ARE NOT COVERED BY THIS LIMITED WARRANTY ARE YOUR RESPONSIBILITY.

Other Information

This product utilizes the following so called “open source” software:

- (1) the software which is licensed under the GNU GENERAL PUBLIC LICENSE,
- (2) the software which is licensed under the GNU LESSER GENERAL PUBLIC LICENSE, and
- (3) software developed by the third parties and available under certain terms and conditions.

For the software categorized as (1) and (2), please refer to the terms and conditions of the following GNU GENERAL PUBLIC LICENSE and GNU LESSER GENERAL PUBLIC LICENSE respectively.

If you wish to get further information as to the software, please contact the web site below.

<http://www.fsf.org/licenses/> and <http://www.am-linux.jp/>

GNU GENERAL PUBLIC LICENSE

Version 2, June 1991

Copyright © 1989, 1991 Free Software Foundation, Inc.

59 Temple Place, Suite 330, Boston, MA 02111-1307 USA

Everyone is permitted to copy and distribute verbatim copies of this license document, but changing it is not allowed.

Preamble

The licenses for most software are designed to take away your freedom to share and change it. By contrast, the GNU General Public License is intended to guarantee your freedom to share and change free software--to make sure the software is free for all its users. This General Public License applies to most of the Free Software Foundation's software and to any other program whose authors commit to using it. (Some other Free Software Foundation software is covered by the GNU Library General Public License instead.) You can apply it to your programs, too.

When we speak of free software, we are referring to freedom, not price. Our General Public Licenses are designed to make sure that you have the freedom to distribute copies of free software (and charge for this service if you wish), that you receive source code or can get it if you want it, that you can change the software or use pieces of it in new free programs; and that you know you can do these things.

To protect your rights, we need to make restrictions that forbid anyone to deny you these rights or to ask you to surrender the rights. These restrictions translate to certain responsibilities for you if you distribute copies of the software, or if you modify it.

For example, if you distribute copies of such a program, whether gratis or for a fee, you must give the recipients all the rights that you have. You must make sure that they, too, receive or can get the source code. And you must show them these terms so they know their rights.

We protect your rights with two steps: (1) copyright the software, and (2) offer you this license which gives you legal permission to copy, distribute and/or modify the software.

Also, for each author's protection and ours, we want to make certain that everyone understands that there is no warranty for this free software. If the software is modified by someone else and passed on, we want its recipients to know that what they have is not the original, so that any problems introduced by others will not reflect on the original authors' reputations.

Finally, any free program is threatened constantly by software patents. We wish to avoid the danger that redistributors of a free program will individually obtain patent licenses, in effect making the program proprietary. To prevent this, we have made it clear that any patent must be licensed for everyone's free use or not licensed at all.

The precise terms and conditions for copying, distribution and modification follow.

TERMS AND CONDITIONS FOR COPYING, DISTRIBUTION AND MODIFICATION

0. This License applies to any program or other work which contains a notice placed by the copyright holder saying it may be distributed under the terms of this General Public License. The “Program”, below, refers to any such program or work, and a “work based on the Program” means either the Program or any derivative work under copyright law: that is to say, a work containing the Program or a portion of it, either verbatim or with modifications and/or translated into another language. (Hereinafter, translation is included without limitation in the term “modification”.) Each licensee is addressed as “you”.

Activities other than copying, distribution and modification are not covered by this License; they are outside its scope. The act of running the Program is not restricted, and the output from the Program is covered only if its contents constitute a work based on the Program (independent of having been made by running the Program). Whether that is true depends on what the Program does.

1. You may copy and distribute verbatim copies of the Program's source code as you receive it, in any medium, provided that you conspicuously and appropriately publish on each copy an appropriate copyright notice and disclaimer of warranty; keep intact all the notices that refer to this License and to the absence of any warranty; and give any other recipients of the Program a copy of this License along with the Program.

You may charge a fee for the physical act of transferring a copy, and you may at your option offer warranty protection in exchange for a fee.

2. You may modify your copy or copies of the Program or any portion of it, thus forming a work based on the Program, and copy and distribute such modifications or work under the terms of Section 1 above, provided that you also meet all of these conditions:

- a) You must cause the modified files to carry prominent notices stating that you changed the files and the date of any change.
- b) You must cause any work that you distribute or publish, that in whole or in part contains or is derived from the Program or any part thereof, to be licensed as a whole at no charge to all third parties under the terms of this License.
- c) If the modified program normally reads commands interactively when run, you must cause it, when started running for such interactive use in the most ordinary way, to print or display an announcement including an appropriate copyright notice and a notice that there is no warranty (or else, saying that you provide a warranty) and that users may redistribute the program under these conditions, and telling the user how to view a copy of this License. (Exception: if the Program itself is interactive but does not normally print such an announcement, your work based on the Program is not required to print an announcement.)

These requirements apply to the modified work as a whole. If identifiable sections of that work are not derived from the Program, and can be reasonably considered independent and separate works in themselves, then this License, and its terms, do not apply to those sections when you distribute them as separate works. But when you distribute the same sections as part of a whole which is a work based on the Program, the distribution of the whole must be on the terms of this License, whose permissions for other licensees extend to the entire whole, and thus to each and every part regardless of who wrote it.

Thus, it is not the intent of this section to claim rights or contest your rights to work written entirely by you; rather, the intent is to exercise the right to control the distribution of derivative or collective works based on the Program.

In addition, mere aggregation of another work not based on the Program with the Program (or with a work based on the Program) on a volume of a storage or distribution medium does not bring the other work under the scope of this License.

3. You may copy and distribute the Program (or a work based on it, under Section 2) in object code or executable form under the terms of Sections 1 and 2 above provided that you also do one of the following:
 - a) Accompany it with the complete corresponding machine-readable source code, which must be distributed under the terms of Sections 1 and 2 above on a medium customarily used for software interchange; or,
 - b) Accompany it with a written offer, valid for at least three years, to give any third party, for a charge no more than your cost of physically performing source distribution, a complete machine-readable copy of the corresponding source code, to be distributed under the terms of Sections 1 and 2 above on a medium customarily used for software interchange; or,
 - c) Accompany it with the information you received as to the offer to distribute corresponding source code. (This alternative is allowed only for noncommercial distribution and only if you received the program in object code or executable form with such an offer, in accord with Subsection b above.)

The source code for a work means the preferred form of the work for making modifications to it. For an executable work, complete source code means all the source code for all modules it contains, plus any associated interface definition files, plus the scripts used to control compilation and installation of the executable. However, as a special exception, the source code distributed need not include anything that is normally distributed (in either source or binary form) with the major components (compiler, kernel, and so on) of the operating system on which the executable runs, unless that component itself accompanies the executable.

If distribution of executable or object code is made by offering access to copy from a designated place, then offering equivalent access to copy the source code from the same place counts as distribution of the source code, even though third parties are not compelled to copy the source along with the object code.

4. You may not copy, modify, sublicense, or distribute the Program except as expressly provided under this License. Any attempt otherwise to copy, modify, sublicense or distribute the Program is void, and will automatically terminate your rights under this License. However, parties who have received copies, or rights, from you under this License will not have their licenses terminated so long as such parties remain in full compliance.

5. You are not required to accept this License, since you have not signed it. However, nothing else grants you permission to modify or distribute the Program or its derivative works. These actions are prohibited by law if you do not accept this License. Therefore, by modifying or distributing the Program (or any work based on the Program), you indicate your acceptance of this License to do so, and all its terms and conditions for copying, distributing or modifying the Program or works based on it.
6. Each time you redistribute the Program (or any work based on the Program), the recipient automatically receives a license from the original licensor to copy, distribute or modify the Program subject to these terms and conditions. You may not impose any further restrictions on the recipients' exercise of the rights granted herein. You are not responsible for enforcing compliance by third parties to this License.
7. If, as a consequence of a court judgment or allegation of patent infringement or for any other reason (not limited to patent issues), conditions are imposed on you (whether by court order, agreement or otherwise) that contradict the conditions of this License, they do not excuse you from the conditions of this License. If you cannot distribute so as to satisfy simultaneously your obligations under this License and any other pertinent obligations, then as a consequence you may not distribute the Program at all. For example, if a patent license would not permit royalty-free redistribution of the Program by all those who receive copies directly or indirectly through you, then the only way you could satisfy both it and this License would be to refrain entirely from distribution of the Program.

If any portion of this section is held invalid or unenforceable under any particular circumstance, the balance of the section is intended to apply and the section as a whole is intended to apply in other circumstances.

It is not the purpose of this section to induce you to infringe any patents or other property right claims or to contest validity of any such claims; this section has the sole purpose of protecting the integrity of the free software distribution system, which is implemented by public license practices. Many people have made generous contributions to the wide range of software distributed through that system in reliance on consistent application of that system; it is up to the author/donor to decide if he or she is willing to distribute software through any other system and a licensee cannot impose that choice.

This section is intended to make thoroughly clear what is believed to be a consequence of the rest of this License.

8. If the distribution and/or use of the Program is restricted in certain countries either by patents or by copyrighted interfaces, the original copyright holder who places the Program under this License may add an explicit geographical distribution limitation excluding those countries, so that distribution is permitted only in or among countries not thus excluded. In such case, this License incorporates the limitation as if written in the body of this License.
9. The Free Software Foundation may publish revised and/or new versions of the General Public License from time to time. Such new versions will be similar in spirit to the present version, but may differ in detail to address new problems or concerns.

Each version is given a distinguishing version number. If the Program specifies a version number of this License which applies to it and "any later version", you have the option of following the terms and conditions either of that version or of any later version published by the Free Software Foundation. If the Program does not specify a version number of this License, you may choose any version ever published by the Free Software Foundation.

Other Information (continued)

10. If you wish to incorporate parts of the Program into other free programs whose distribution conditions are different, write to the author to ask for permission. For software which is copyrighted by the Free Software Foundation, write to the Free Software Foundation; we sometimes make exceptions for this. Our decision will be guided by the two goals of preserving the free status of all derivatives of our free software and of promoting the sharing and reuse of software generally.

NO WARRANTY

11. BECAUSE THE PROGRAM IS LICENSED FREE OF CHARGE, THERE IS NO WARRANTY FOR THE PROGRAM, TO THE EXTENT PERMITTED BY APPLICABLE LAW. EXCEPT WHEN OTHERWISE STATED IN WRITING THE COPYRIGHT HOLDERS AND/OR OTHER PARTIES PROVIDE THE PROGRAM "AS IS" WITHOUT WARRANTY OF ANY KIND, EITHER EXPRESSED OR IMPLIED, INCLUDING, BUT NOT LIMITED TO, THE IMPLIED WARRANTIES OF MERCHANTABILITY AND FITNESS FOR A PARTICULAR PURPOSE. THE ENTIRE RISK AS TO THE QUALITY AND PERFORMANCE OF THE PROGRAM IS WITH YOU. SHOULD THE PROGRAM PROVE DEFECTIVE, YOU ASSUME THE COST OF ALL NECESSARY SERVICING, REPAIR OR CORRECTION.
12. IN NO EVENT UNLESS REQUIRED BY APPLICABLE LAW OR AGREED TO IN WRITING WILL ANY COPYRIGHT HOLDER, OR ANY OTHER PARTY WHO MAY MODIFY AND/OR REDISTRIBUTE THE PROGRAM AS PERMITTED ABOVE, BE LIABLE TO YOU FOR DAMAGES, INCLUDING ANY GENERAL, SPECIAL, INCIDENTAL OR CONSEQUENTIAL DAMAGES ARISING OUT OF THE USE OR INABILITY TO USE THE PROGRAM (INCLUDING BUT NOT LIMITED TO LOSS OF DATA OR DATA BEING RENDERED INACCURATE OR LOSSES SUSTAINED BY YOU OR THIRD PARTIES OR A FAILURE OF THE PROGRAM TO OPERATE WITH ANY OTHER PROGRAMS), EVEN IF SUCH HOLDER OR OTHER PARTY HAS BEEN ADVISED OF THE POSSIBILITY OF SUCH DAMAGES.

END OF TERMS AND CONDITIONS

How to Apply These Terms to Your New Programs

If you develop a new program, and you want it to be of the greatest possible use to the public, the best way to achieve this is to make it free software which everyone can redistribute and change under these terms.

To do so, attach the following notices to the program. It is safest to attach them to the start of each source file to most effectively convey the exclusion of warranty; and each file should have at least the "copyright" line and a pointer to where the full notice is found.

```
<one line to give the program's name and an idea of what it does.>  
Copyright © <year> <name of author>
```

This program is free software; you can redistribute it and/or modify it under the terms of the GNU General Public License as published by the Free Software Foundation; either version 2 of the License, or (at your option) any later version.

This program is distributed in the hope that it will be useful, but WITHOUT ANY WARRANTY; without even the implied warranty of MERCHANTABILITY or FITNESS FOR A PARTICULAR PURPOSE. See the GNU General Public License for more details.

You should have received a copy of the GNU General Public License along with this program; if not, write to the Free Software Foundation, Inc., 59 Temple Place - Suite 330, Boston, MA 02111-1307, USA

Also add information on how to contact you by electronic and paper mail. If a program is interactive, make it output a short notice like this when it starts in an interactive mode:

```
Gnomovision version 69, Copyright © year name of author  
Gnomovision comes with ABSOLUTELY NO WARRANTY; for details  
type show w'.  
This is free software, and you are welcome to redistribute it under certain  
conditions; type `show c' for details.
```

The hypothetical commands `show w' and `show c' should show the appropriate parts of the General Public License. Of course, the commands you use may be called something other than `show w' and `show c'; they could even be mouse-clicks or menu items--whatever suits your program.

You should also get your employer (if you work as a programmer) or your school, if any, to sign a "copyright disclaimer" for the program, if necessary. Here is a sample; alter the names:

Yoyodyne, Inc., hereby disclaims all copyright interest in the program `Gnomovision' (which makes passes at compilers) written by James Hacker.

```
<signature of Ty Coon>, 1 April 1989  
Ty Coon, President of Vice
```

This General Public License does not permit incorporating your program into proprietary programs. If your program is a subroutine library, you may consider it more useful to permit linking proprietary applications with the library. If this is what you want to do, use the GNU Library General Public License instead of this License.

GNU LESSER GENERAL PUBLIC LICENSE

Version 2.1, February 1999

Copyright © 1991, 1999 Free Software Foundation, Inc.

59 Temple Place, Suite 330, Boston, MA 02111-1307 USA

Everyone is permitted to copy and distribute verbatim copies of this license document, but changing it is not allowed.

[This is the first released version of the Lesser GPL. It also counts as the successor of the GNU Library Public License, version 2, hence the version number 2.1.]

Preamble

The licenses for most software are designed to take away your freedom to share and change it. By contrast, the GNU General Public Licenses are intended to guarantee your freedom to share and change free software--to make sure the software is free for all its users.

This license, the Lesser General Public License, applies to some specially designated software packages--typically libraries--of the Free Software Foundation and other authors who decide to use it. You can use it too, but we suggest you first think carefully about whether this license or the ordinary General Public License is the better strategy to use in any particular case, based on the explanations below.

When we speak of free software, we are referring to freedom of use, not price. Our General Public Licenses are designed to make sure that you have the freedom to distribute copies of free software (and charge for this service if you wish); that you receive source code or can get it if you want it; that you can change the software and use pieces of it in new free programs; and that you are informed that you can do these things.

To protect your rights, we need to make restrictions that forbid distributors to deny you these rights or to ask you to surrender these rights. These restrictions translate to certain responsibilities for you if you distribute copies of the library or if you modify it.

For example, if you distribute copies of the library, whether gratis or for a fee, you must give the recipients all the rights that we gave you. You must make sure that they, too, receive or can get the source code. If you link other code with the library, you must provide complete object files to the recipients, so that they can relink them with the library after making changes to the library and recompiling it. And you must show them these terms so they know their rights.

We protect your rights with a two-step method: (1) we copyright then library, and (2) we offer you this license, which gives you legal permission to copy, distribute and/or modify the library.

To protect each distributor, we want to make it very clear that there is no warranty for the free library. Also, if the library is modified by someone else and passed on, the recipients should know that what they have is not the original version, so that the original author's reputation will not be affected by problems that might be introduced by others.

Finally, software patents pose a constant threat to the existence of any free program. We wish to make sure that a company cannot effectively restrict the users of a free program by obtaining a restrictive license from a patent holder. Therefore, we insist that any patent license obtained for a version of the library must be consistent with the full freedom of use specified in this license.

Most GNU software, including some libraries, is covered by the ordinary GNU General Public License. This license, the GNU Lesser General Public License, applies to certain designated libraries, and is quite different from the ordinary General Public License. We use this license for certain libraries in order to permit linking those libraries into non-free programs.

When a program is linked with a library, whether statically or using a shared library, the combination of the two is legally speaking a combined work, a derivative of the original library. The ordinary General Public License therefore permits such linking only if the entire combination fits its criteria of freedom. The Lesser General Public License permits more lax criteria for linking other code with the library.

We call this license the "Lesser" General Public License because it does Less to protect the user's freedom than the ordinary General Public License. It also provides other free software developers Less of an advantage over competing non-free programs. These disadvantages are the reason we use the ordinary General Public License for many libraries. However, the Lesser license provides advantages in certain special circumstances.

For example, on rare occasions, there may be a special need to encourage the widest possible use of a certain library, so that it becomes a de-facto standard. To achieve this, non-free programs must be allowed to use the library. A more frequent case is that a free library does the same job as widely used non-free libraries. In this case, there is little to gain by limiting the free library to free software only, so we use the Lesser General Public License.

In other cases, permission to use a particular library in non-free programs enables a greater number of people to use a large body of free software. For example, permission to use the GNU C Library in non-free programs enables many more people to use the whole GNU operating system, as well as its variant, the GNU/Linux operating system.

Although the Lesser General Public License is Less protective of the users' freedom, it does ensure that the user of a program that is linked with the Library has the freedom and the wherewithal to run that program using a modified version of the Library.

The precise terms and conditions for copying, distribution and modification follow. Pay close attention to the difference between a "work based on the library" and a "work that uses the library". The former contains code derived from the library, whereas the latter must be combined with the library in order to run.

Other Information (continued)

TERMS AND CONDITIONS FOR COPYING, DISTRIBUTION AND MODIFICATION

0. This License Agreement applies to any software library or other program which contains a notice placed by the copyright holder or other authorized party saying it may be distributed under the terms of this Lesser General Public License (also called “this License”). Each licensee is addressed as “you”.

A “library” means a collection of software functions and/or data prepared so as to be conveniently linked with application programs (which use some of those functions and data) to form executables.

The “Library”, below, refers to any such software library or work which has been distributed under these terms. A “work based on the Library” means either the Library or any derivative work under copyright law: that is to say, a work containing the Library or a portion of it, either verbatim or with modifications and/or translated straightforwardly into another language. (Hereinafter, translation is included without limitation in the term “modification”.)

“Source code” for a work means the preferred form of the work for making modifications to it. For a library, complete source code means all the source code for all modules it contains, plus any associated interface definition files, plus the scripts used to control compilation and installation of the library.

Activities other than copying, distribution and modification are not covered by this License; they are outside its scope. The act of running a program using the Library is not restricted, and output from such a program is covered only if its contents constitute a work based on the Library (independent of the use of the Library in a tool for writing it). Whether that is true depends on what the Library does and what the program that uses the Library does.

1. You may copy and distribute verbatim copies of the Library’s complete source code as you receive it, in any medium, provided that you conspicuously and appropriately publish on each copy an appropriate copyright notice and disclaimer of warranty; keep intact all the notices that refer to this License and to the absence of any warranty; and distribute a copy of this License along with the Library.

You may charge a fee for the physical act of transferring a copy, and you may at your option offer warranty protection in exchange for a fee.

2. You may modify your copy or copies of the Library or any portion of it, thus forming a work based on the Library, and copy and distribute such modifications or work under the terms of Section 1 above, provided that you also meet all of these conditions:
 - a) The modified work must itself be a software library.
 - b) You must cause the files modified to carry prominent notices stating that you changed the files and the date of any change.
 - c) You must cause the whole of the work to be licensed at no charge to all third parties under the terms of this License.
 - d) If a facility in the modified Library refers to a function or a table of data to be supplied by an application program that uses the facility, other than as an argument passed when the facility is invoked, then you must make a good faith effort to ensure that, in the event an application does not supply such function or table, the facility still operates, and performs whatever part of its purpose remains meaningful.

(For example, a function in a library to compute square roots has a purpose that is entirely well-defined independent of the application. Therefore, Subsection 2d requires that any application-supplied function or table used by this function must be optional: if the application does not supply it, the square root function must still compute square roots.)

These requirements apply to the modified work as a whole. If identifiable sections of that work are not derived from the Library, and can be reasonably considered independent and separate works in themselves, then this License, and its terms, do not apply to those sections when you distribute them as separate works. But when you distribute the same sections as part of a whole which is a work based on the Library, the distribution of the whole must be on the terms of this License, whose permissions for other licensees extend to the entire whole, and thus to each and every part regardless of who wrote it.

Thus, it is not the intent of this section to claim rights or contest your rights to work written entirely by you; rather, the intent is to exercise the right to control the distribution of derivative or collective works based on the Library.

In addition, mere aggregation of another work not based on the Library with the Library (or with a work based on the Library) on a volume of a storage or distribution medium does not bring the other work under the scope of this License.

3. You may opt to apply the terms of the ordinary GNU General Public License instead of this License to a given copy of the Library. To do this, you must alter all the notices that refer to this License, so that they refer to the ordinary GNU General Public License, version 2, instead of to this License. (If a newer version than version 2 of the ordinary GNU General Public License has appeared, then you can specify that version instead if you wish.) Do not make any other change in these notices.

Once this change is made in a given copy, it is irreversible for that copy, so the ordinary GNU General Public License applies to all subsequent copies and derivative works made from that copy.

This option is useful when you wish to copy part of the code of the Library into a program that is not a library.

4. You may copy and distribute the Library (or a portion or derivative of it, under Section 2) in object code or executable form under the terms of Sections 1 and 2 above provided that you accompany it with the complete corresponding machine-readable source code, which must be distributed under the terms of Sections 1 and 2 above on a medium customarily used for software interchange.

If distribution of object code is made by offering access to copy from a designated place, then offering equivalent access to copy the source code from the same place satisfies the requirement to distribute the source code, even though third parties are not compelled to copy the source along with the object code.

5. A program that contains no derivative of any portion of the Library, but is designed to work with the Library by being compiled or linked with it, is called a “work that uses the Library”. Such a work, in isolation, is not a derivative work of the Library, and therefore falls outside the scope of this License.

However, linking a “work that uses the Library” with the Library creates an executable that is a derivative of the Library (because it contains portions of the Library), rather than a “work that uses the library”. The executable is therefore covered by this License. Section 6 states terms for distribution of such executables.

When a “work that uses the Library” uses material from a header file that is part of the Library, the object code for the work may be a derivative work of the Library even though the source code is not. Whether this is true is especially significant if the work can be linked without the Library, or if the work is itself a library. The threshold for this to be true is not precisely defined by law.

If such an object file uses only numerical parameters, data structure layouts and accessors, and small macros and small inline functions (ten lines or less in length), then the use of the object file is unrestricted, regardless of whether it is legally a derivative work. (Executables containing this object code plus portions of the Library will still fall under Section 6.)

Otherwise, if the work is a derivative of the Library, you may distribute the object code for the work under the terms of Section 6. Any executables containing that work also fall under Section 6, whether or not they are linked directly with the Library itself.

6. As an exception to the Sections above, you may also combine or link a “work that uses the Library” with the Library to produce a work containing portions of the Library, and distribute that work under terms of your choice, provided that the terms permit modification of the work for the customer’s own use and reverse engineering for debugging such modifications.

You must give prominent notice with each copy of the work that the Library is used in it and that the Library and its use are covered by this License. You must supply a copy of this License. If the work during execution displays copyright notices, you must include the copyright notice for the Library among them, as well as a reference directing the user to the copy of this License. Also, you must do one of these things:

- a) Accompany the work with the complete corresponding machine-readable source code for the Library including whatever changes were used in the work (which must be distributed under Sections 1 and 2 above); and, if the work is an executable linked with the Library, with the complete machine-readable “work that uses the Library”, as object code and/or source code, so that the user can modify the Library and then relink to produce a modified executable containing the modified Library. (It is understood that the user who changes the contents of definitions files in the Library will not necessarily be able to recompile the application to use the modified definitions.)
- b) Use a suitable shared library mechanism for linking with the Library. A suitable mechanism is one that (1) uses at run time a copy of the library already present on the user’s computer system, rather than copying library functions into the executable, and (2) will operate properly with a modified version of the library, if the user installs one, as long as the modified version is interface-compatible with the version that the work was made with.
- c) Accompany the work with a written offer, valid for at least three years, to give the same user the materials specified in Subsection 6a, above, for a charge no more than the cost of performing this distribution.
- d) If distribution of the work is made by offering access to copy from a designated place, offer equivalent access to copy the above specified materials from the same place.
- e) Verify that the user has already received a copy of these materials or that you have already sent this user a copy.

For an executable, the required form of the “work that uses the Library” must include any data and utility programs needed for reproducing the executable from it. However, as a special exception, the materials to be distributed need not include anything that is normally distributed (in either source or binary form) with the major components (compiler, kernel, and so on) of the operating system on which the executable runs, unless that component itself accompanies the executable.

It may happen that this requirement contradicts the license restrictions of other proprietary libraries that do not normally accompany the operating system. Such a contradiction means you cannot use both them and the Library together in an executable that you distribute.

7. You may place library facilities that are a work based on the Library side-by-side in a single library together with other library facilities not covered by this License, and distribute such a combined library, provided that the separate distribution of the work based on the Library and of the other library facilities is otherwise permitted, and provided that you do these two things:

- a) Accompany the combined library with a copy of the same work based on the Library, uncombined with any other library facilities. This must be distributed under the terms of the Sections above.
- b) Give prominent notice with the combined library of the fact that part of it is a work based on the Library, and explaining where to find the accompanying uncombined form of the same work.

8. You may not copy, modify, sublicense, link with, or distribute the Library except as expressly provided under this License. Any attempt otherwise to copy, modify, sublicense, link with, or distribute the Library is void, and will automatically terminate your rights under this License. However, parties who have received copies, or rights, from you under this License will not have their licenses terminated so long as such parties remain in full compliance.

9. You are not required to accept this License, since you have not signed it. However, nothing else grants you permission to modify or distribute the Library or its derivative works. These actions are prohibited by law if you do not accept this License. Therefore, by modifying or distributing the Library (or any work based on the Library), you indicate your acceptance of this License to do so, and all its terms and conditions for copying, distributing or modifying the Library or works based on it.

10. Each time you redistribute the Library (or any work based on the Library), the recipient automatically receives a license from the original licensor to copy, distribute, link with or modify the Library subject to these terms and conditions. You may not impose any further restrictions on the recipients’ exercise of the rights granted herein. You are not responsible for enforcing compliance by third parties with this License.

11. If, as a consequence of a court judgment or allegation of patent infringement or for any other reason (not limited to patent issues), conditions are imposed on you (whether by court order, agreement or otherwise) that contradict the conditions of this License, they do not excuse you from the conditions of this License. If you cannot distribute so as to satisfy simultaneously your obligations under this License and any other pertinent obligations, then as a consequence you may not distribute the Library at all. For example, if a patent license would not permit royalty-free redistribution of the Library by all those who receive copies directly or indirectly through you, then the only way you could satisfy both it and this License would be to refrain entirely from distribution of the Library.

If any portion of this section is held invalid or unenforceable under any particular circumstance, the balance of the section is intended to apply, and the section as a whole is intended to apply in other circumstances.

It is not the purpose of this section to induce you to infringe any patents or other property right claims or to contest validity of any such claims; this section has the sole purpose of protecting the integrity of the free software distribution system which is implemented by public license practices. Many people have made generous contributions to the wide range of software distributed through that system in reliance on consistent application of that system; it is up to the author/donor to decide if he or she is willing to distribute software through any other system and a licensee cannot impose that choice.

This section is intended to make thoroughly clear what is believed to be a consequence of the rest of this License.

Other Information (continued)

12. If the distribution and/or use of the Library is restricted in certain countries either by patents or by copyrighted interfaces, the original copyright holder who places the Library under this License may add an explicit geographical distribution limitation excluding those countries, so that distribution is permitted only in or among countries not thus excluded. In such case, this License incorporates the limitation as if written in the body of this License.
13. The Free Software Foundation may publish revised and/or new versions of the Lesser General Public License from time to time. Such new versions will be similar in spirit to the present version, but may differ in detail to address new problems or concerns.

Each version is given a distinguishing version number. If the Library specifies a version number of this License which applies to it and “any later version”, you have the option of following the terms and conditions either of that version or of any later version published by the Free Software Foundation. If the Library does not specify a license version number, you may choose any version ever published by the Free Software Foundation.

14. If you wish to incorporate parts of the Library into other free programs whose distribution conditions are incompatible with these, write to the author to ask for permission. For software which is copyrighted by the Free Software Foundation, write to the Free Software Foundation; we sometimes make exceptions for this. Our decision will be guided by the two goals of preserving the free status of all derivatives of our free software and of promoting the sharing and reuse of software generally.

NO WARRANTY

15. BECAUSE THE LIBRARY IS LICENSED FREE OF CHARGE, THERE IS NO WARRANTY FOR THE LIBRARY, TO THE EXTENT PERMITTED BY APPLICABLE LAW. EXCEPT WHEN OTHERWISE STATED IN WRITING THE COPYRIGHT HOLDERS AND/OR OTHER PARTIES PROVIDE THE LIBRARY “AS IS” WITHOUT WARRANTY OF ANY KIND, EITHER EXPRESSED OR IMPLIED, INCLUDING, BUT NOT LIMITED TO, THE IMPLIED WARRANTIES OF MERCHANTABILITY AND FITNESS FOR A PARTICULAR PURPOSE. THE ENTIRE RISK AS TO THE QUALITY AND PERFORMANCE OF THE LIBRARY IS WITH YOU. SHOULD THE LIBRARY PROVE DEFECTIVE, YOU ASSUME THE COST OF ALL NECESSARY SERVICING, REPAIR OR CORRECTION.
16. IN NO EVENT UNLESS REQUIRED BY APPLICABLE LAW OR AGREED TO IN WRITING WILL ANY COPYRIGHT HOLDER, OR ANY OTHER PARTY WHO MAY MODIFY AND/OR REDISTRIBUTE THE LIBRARY AS PERMITTED ABOVE, BE LIABLE TO YOU FOR DAMAGES, INCLUDING ANY GENERAL, SPECIAL, INCIDENTAL OR CONSEQUENTIAL DAMAGES ARISING OUT OF THE USE OR INABILITY TO USE THE LIBRARY (INCLUDING BUT NOT LIMITED TO LOSS OF DATA OR DATA BEING RENDERED INACCURATE OR LOSSES SUSTAINED BY YOU OR THIRD PARTIES OR A FAILURE OF THE LIBRARY TO OPERATE WITH ANY OTHER SOFTWARE), EVEN IF SUCH HOLDER OR OTHER PARTY HAS BEEN ADVISED OF THE POSSIBILITY OF SUCH DAMAGES.

END OF TERMS AND CONDITIONS

How to Apply These Terms to Your New Libraries

If you develop a new library, and you want it to be of the greatest possible use to the public, we recommend making it free software that everyone can redistribute and change. You can do so by permitting redistribution under these terms (or, alternatively, under the terms of the ordinary General Public License).

To apply these terms, attach the following notices to the library. It is safest to attach them to the start of each source file to most effectively convey the exclusion of warranty; and each file should have at least the “copyright” line and a pointer to where the full notice is found.

<one line to give the library’s name and an idea of what it does.>
Copyright © <year> <name of author>

This library is free software; you can redistribute it and/or modify it under the terms of the GNU Lesser General Public License as published by the Free Software Foundation; either version 2.1 of the License, or (at your option) any later version.

This library is distributed in the hope that it will be useful, but WITHOUT ANY WARRANTY; without even the implied warranty of MERCHANTABILITY or FITNESS FOR A PARTICULAR PURPOSE. See the GNU Lesser General Public License for more details.

You should have received a copy of the GNU Lesser General Public License along with this library; if not, write to the Free Software Foundation, Inc., 59 Temple Place, Suite 330, Boston, MA 02111-1307 USA

Also add information on how to contact you by electronic and paper mail.

You should also get your employer (if you work as a programmer) or your school, if any, to sign a “copyright disclaimer” for the library, if necessary. Here is a sample; alter the names:

Yoyodyne, Inc., hereby disclaims all copyright interest in the library ‘Frob’ (a library for tweaking knobs) written by James Random Hacker.

<signature of Ty Coon>, 1 April 1990
Ty Coon, President of Vice

That’s all there is to it!

Index

1080i 16, 23
1080p 23
480i 16, 23
480p 16, 23
720p 16, 23

A

ASPECT button 9, 41
ATSC 8
AUDIO OUT Terminal 19
Auto shut off 26

B

BBE 48
Blocking Messages 53

C

CableCARD 8, 14
CableCARD INTERFACE 14
CC 8, 65–66
Channel up / down buttons 9, 10, 38
Component signal input 1-2 terminals 11, 16
Control with HDMI “HDAVI Control” 68

D

Dolby Digital 8, 19
DTV 8, 38

E

EAS 7, 8

H

HDMI 8, 23, 37, 48
HDMI 1, 2 input terminals 11, 21
HDTV 8

I

Input 1, 2, 3 terminals 10–11, 15
IRIS indicator 10

J

JPEG 8, 54–57
JPEG Thumbnail 55

L

LAMP indicator 10, 75–78
Left screen 42

M

MPAA 8, 50–51
MSO 7, 8
MUTE button 9, 39

N

NTSC 8
NUMBER keys 9, 38

O

OK button 9, 10

P

Password 8, 50, 53
PCM 8, 19, 23
PC input terminal 11, 24
PC position 37, 45
POWER button (Remote Control) 9, 26
POWER button / POWER indicator (Unit) 10, 26, 75

R

R-TUNE button 9, 37
RECALL button 9, 38
Remote Control Sensor 10
Reset All Memory Functions 7
RGB cable 24
Right screen 42

S

SAP button 9, 40
SD Card 54–57
Sleep Timer 40, 49
Sound mute 39
Stereo System 18
SVGA 25

T

TEMP indicator 10, 75
TV/VIDEO button 9, 10, 37

V

VCR connections 15, 17
VGA 25
Volume +/- buttons 9, 10, 38

X

XGA 25

Y

Y, PB, PR 16

Customer's Record

The serial number of this product can be found on its back cover. You should note this serial number in the space provided below and retain this book, plus your purchase receipt, as a permanent record of your purchase to aid in identification in the event of theft or loss, and for Warranty Service purposes.

Model Number

Serial Number

**Panasonic Consumer Electronics Company,
Division of Panasonic Corporation of North America**
One Panasonic Way Secaucus, New Jersey 07094

**Panasonic Sales Company ("PSC"), Division of
Panasonic Puerto Rico, Inc.**
Ave. 65 de Infantería, Km. 9.5
San Gabriel Industrial Park, Carolina, Puerto Rico 00985